

LINEEYE®

Multi Protocol Analyzer

LE-3500R LE-2500R

Battery-powered portable communication analyzer with Wi-Fi* for remote measurement.



MULTI PROTOCOL ANALYZER
LE-3500R

● 210(W)×154(D)×38(H)mm,
Approx. 760 g



Modbus
Supported



MULTI PROTOCOL ANALYZER
LE-2500R

● 210(W)×154(D)×38(H)mm,
Approx. 760 g



Standard
communications



RS-232C

RS-422/485

TTL/UART/I²C/SPI

Expanded
communications



CAN/LIN

CC-Link

Current Loop

RS-530/X.20/X.21/V.35

LINEEYE®

*Wi-Fi function is available only in Japan, USA, and Canada.

Battery-powered portable communication analyzer.

MULTI PROTOCOL ANALYZER **LE-3500R / LE-2500R**

LINEEYE released the first LE-series model in 1986. Since then, LINEEYE has been developing the LE Series in response to the requirements of a large number of customers, and now come to the fruition of the LE-3500R and LE-2500R which support remote measurement by Wi-Fi in the IoT era. The LE-3500R and LE-2500R incorporate versatile analysis functions and excellent portability, thus fully supporting the trouble analysis of communications systems, industrial equipment, and a variety of in-vehicle networks as well as development tests and after-sale services.



Special data items are expressed in individual signs.

(Example of display signs)	
	HDLC/SDLC flag
	Short frame
	Block check : Good
	Block check : Error
	Parity error
	Framing error
	PE and FE simultaneous error
	Break

Idle time (frame interval time)

Time stamp (frame arrival time)

Menu key

Measurement start key

Line state LED

Continuously displays the state of communications line with a 2-color LED.

In RS-232C communications
 Red: ON space state
 Green: OFF mark state
 OFF: Not in use or not wired

SPEED In half-duplex mode

- 4M bps
- 2M bps
- 1 M bps
- 500Kbps



COMPACT PROTOCOL ANALYZER **LE-1500**

An entry model dedicated to Async/PPP which has a sufficient measurement function with moderate price.

*See the LE-1500 catalog for details.

- Max speed 500Kbps
- 2.4MB Memory
- 8GB CF card support



MULTI PROTOCOL ANALYZER **LE-2500R**

A high cost-performance multi-protocol model with expandability.

- Max speed 1Mbps
- 64MB Memory
- 16GB USB Flash Drive/SD card support



MULTI PROTOCOL ANALYZER **LE-3500R**

A perfect model incorporating statistical analysis and program simulation functions.

- Max speed 2Mbps
- 64MB Memory
- 32GB USB Flash Drive/SD card support



MULTI PROTOCOL ANALYZER **LE-8200A LE-8200**

The high-end model boasting plentiful performance with a large-sized color display and versatile functions.

*See the LE-8200(A) catalog for details.

- Max speed 4Mbps
- 100MB Memory
- 128GB CF card support
- USB Flash Drive (LE-8200A)

Async, PPP

Multi Protocol (Async, Sync, BSC, SDLC, HDLC, X25, PPP, I²C, CAN, LIN ...)

Measures UART/I²C/SPI without using optional board.

It has a measurement port for TTL(1.8V – 5V) as its standard port. Measurement tests for sensor, LAN and wireless modules of I²C, SPI, and UART interface, for AD conversion IC, or for memory IC are available without changing the measurement board.

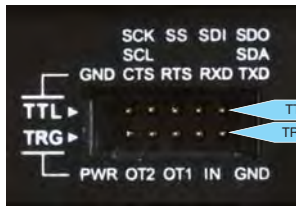

TTL line : Terminals for UART, I²C, and SPI

TRG line : External trigger input/output, PWR terminal

Note: The voltage of selected signal level (1.8 / 2.5 / 3.3 / 5V) is output from the PWR terminal.

Pin header connector of 2.54mm pitch, equivalent to HIF3FC-10PA-2.54DS(71)(HIROSE ELECTRIC CO., LTD.)

[A 5-wires TTL prove cable is attached]



It can be used for TTL communication signal and external trigger signal. If you want to use both of them at the same time, purchase one more this prove cable.



[Interface setting]

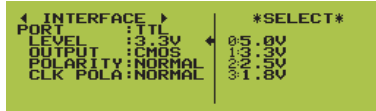

[I²C monitor display example]



[SPI monitor display example]

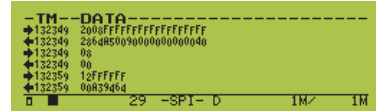

Supports RS-232C of DSUB 9 pin

A monitor cable for DSUB25 pin, a monitor cable for DSUB9 pin, and a changer for DSUB25 pin to DSUB9 pin are attached. You can connect devices of DSUB25 pin or DSUB9 pin without any optional cables.



Detachable terminal for RS-422/485

RS-422/485 cable can be connected with the analyzer directly. As it is detachable, you do not need to unscrew the cables, when disconnecting the analyzer from the monitoring line.



Mega Speed Measurement

Analysis is possible at any baud rate from low speed to high speed.(*)
Margin tests on communication speed deviation are simple.

[Baud rate setting display]



* Using high precision DPLL technology for open baud rate support, transmission and reception speeds can be separately set to an effective 4 digits.

Remote Control by Wi-Fi*1

You can analyze the log data or convert the data into text file on your PC by connecting the PC in which the PC link software is installed with protocol analyzer(s) by USB or Wi-Fi. You can also capture the screen image of analyzer in the Android smart phone display to send it by email by connecting the smart phone with the analyzer by Wi-Fi.

*1 The light edition of the PC link software for Windows PC "LE-PC300R" is attached. The application for Android smart phone "LE-REMOTE4" can be downloaded from Google Play. Wi-Fi function is available only in USA, Canada, and Japan.

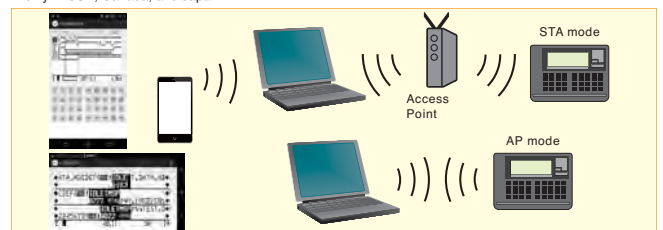

>>> See page 7 >>>

Auto Save/Long Recording Time

You can record communications data into the 64MB memory endlessly or stop recording it automatically when the memory is full. Furthermore, an auto save function makes it possible to save the monitored content of captured memory into a SD card or a USB flash. Auto Save continuously saves data into the measurement log of a user-specified file size, using ring recording as long as the card has space. It is useful for identifying rare communication failures of unknown cause



[SD card / USB flash are supported]

Target line speed (bps)	Continuous recording time reference(LE-3500R)	
	Main memory only	When using 32GB SDHC card
9600	Approx. 3.5 hrs	Approx. 80 days
115.2K	Approx. 18 min	Approx. 6.5 days
1M	Approx. 140 sec	Approx. 20 hrs

* Calculated for full-duplex transmission of 1,000 byte data frames per second. If the interval of frames are longer, the recording time will be longer.

Logic Analyzer and Signal Voltage Measurement

Communication line timing is analyzed and displayed as a logic analyzer display to a time resolution of max. 50 ns. You can measure the voltage level of RS-232C or TTL signals by the signal voltage measurement function.

[Example of logic analyzer measurement]

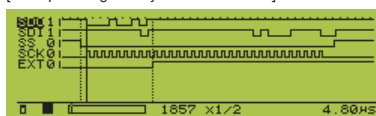

[Example of signal voltage measurement]

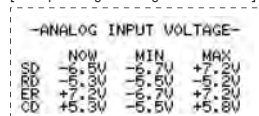

Expands measurement targets

Measurement targets can be expanded by optional measurement boards or connection cables.



>>> See page 8 - 9 >>>

A monitor function to visualize communications data.

Supports multi-protocols

The online monitor feature records communications data in the capture memory and provides an easy-to-understand display for the type of protocol, without affecting the communications line. As a standard feature, LINEEYE protocol analyzers support various communications standards from asynchronous to packet communication. Depending on the test, you can select bit transfer sequence and polarity, as well as modulation format from NRZ, NRZI, FMO, FM1. The feature allows to support effective analysis by omitting SYN codes and using SDLC/HDLC address filter.

[Data display]

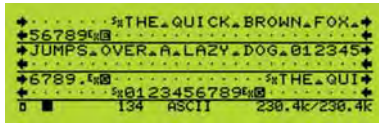

[Example X.25 protocol translation]

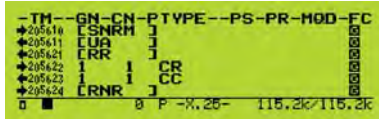

[Example PPP translation]



Line state LED



Communications line state is indicated in real time using 2-color LEDs

[Example of connection for online monitoring]

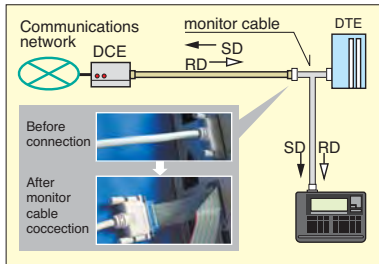

Trigger Feature for Catching User-specified Events

The trigger feature allows you to specify a communications event as the trigger condition and has measurement operations executed automatically when that condition is satisfied. Up to four pairs of conditions and operations can be set, which is helpful towards identifying frequent intermittent faults that occurs with communications systems. And, the operation of a trigger condition can be specified as the condition for another trigger, making it possible to analyze complicated operations based on sequential triggers.

[Trigger setup summary display]



[Example trigger condition setup]



[Example trigger action setup]



Monitor Condition Auto Setting

LINEEYE protocol analyzers can analyze communications data and automatically set basic measuring conditions, such as communications speed, character framing, data code, synchronization character, BCC/FCS, etc. This is effective for monitoring lines of unknown communications conditions.

[Monitor condition auto setting - Search display]



[Monitor condition auto setting - Determination display]



*The auto setting is not accurate with small volumes of communications data or data that contains many errors.

Records Time Data with Communication Data

LINEEYE protocol analyzers record not only communications data but the time (time stamp) of transmissions and receptions as well as idle time; therefore failure time and timeout status can be checked. It is also possible to record the information of changes in control lines at the same time. For ASYNC/BURST communications, setting the idle time to be the frame end is available in the range of 1 to 100ms.

[Example record data selection]



[Time stamp / idle time display]



[Timing data display]

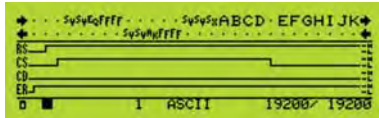

Signal voltage measurement feature for RS-232C and TTL

You can measure the voltage (current value, maximum, minimum) of 4 signal lines of RS-232C or TTL measurement port. You can also measure delay time of control line change (such as the change from RTS to CTS).

[Example delay time measurement]

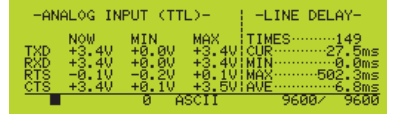

Statistical Analysis Capabilities

Only for LE-3500R

Statistics can be compiled for transmission and reception data sets, frames and the number of established trigger events, and subsequently displayed as a graph (Unit: 1-240 min.). This helps to understand communications traffic and error frequency for a specific time period.

[Graph of statistically analyzed data]



BERT function to measure the occurrence rate of communications errors.

BERT function enables you to measure transmission quality of communications lines by a loop-back or interactive connection. It is possible to measure evaluation parameters (bit error count, block error count) conforming to ITU-T G.821 Notification, hence enabling bit error rate evaluations and fault point identification. Elaborate test patterns and functions such as bit error forced interrupt are comparable to dedicated equipment.

[Example connection for BERT]

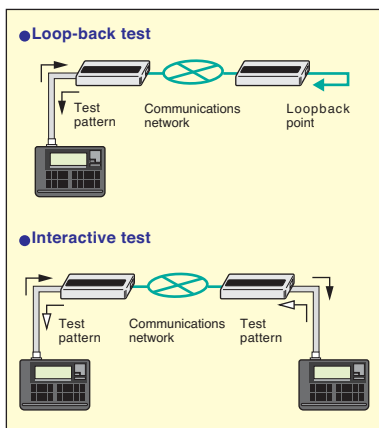

Evaluation is possible in ASYNC or SYNC mode, by specifying measurement period (continuous, received bits, specified time, repeat) or test pattern.

[BERT setting display]



Once started, the results of measured line quality are displayed and updated in real time. When finding the error bit, LINEEYE analyzers can output the external trigger to inform other equipments. Repeat mode allows you to know the error rate for the specific time range in the communication lines.

[Example BERT measurement]



[Contents of BERT measurement]

Savail	Available measurement in seconds	0~9999999	Loss	SYNC loss count	0~9999
R-Bit	Effective bits received	0~9999999~9.99E9	R-Blk	Effective blocks received	0~9999999~9.99E9
E-Bit	Error bit count	0~9999999~9.99E9	E-Blk	Block error count	0~9999999~9.99E9
Bit-ER	Bit error rate	0~9.99E-9~1	Blk-ER	Block error rate	0~9.99E-9~1
E-Sec	Error in seconds	0~9999	%E.F.S	Normal operation rate	0.000~100.000%

MULTI PROTOCOL ANALYZER LE-3500R / LE-2500R

Online Monitoring, Simulation and BERT Support All-in-One

Must-have measurement tool for on-site test or communication trouble analysis.

Simulation function to conduct transmission and reception tests in place of target equipment under test.

With the simulation feature, the LINEEYE protocol analyzers act as the counterpart to the target device and perform transmission and reception tests according to protocol. Even in the early stages of development when matching devices are not available, tests can be run at near to actual operating status. After checking the communications protocol step by step in LINEEYE analyzer's own original MANUAL mode, a developer can create a simple program to branch conditions using menu selection and test more complicated communications protocols. Communications speed can be freely set; therefore margins can be evaluated by intentionally shifting communications speed, and error response processing can be checked using test data that mixes in data with parity errors. In addition, data transmission can be linked with the changes in the signal lines such as RTS and CTS at the preset timing.

[Control lines and data transmission timing]



[Example of connection for simulation]

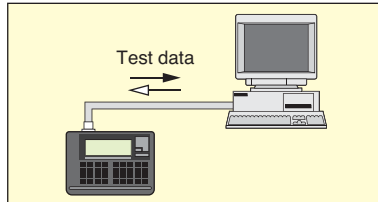

MANUAL mode

The MANUAL mode allows you to send the data registered in transmission table which corresponds to the "0" to "F" keys (10 groups, 16 types for each). The data can be sent with one press of a key. While checking replies from a unit under development with the monitoring feature, you can easily and simply test the communications process. You can also send fixed data by registering it under a key combination of the SHIFT and "0" to "D" keys, as well as turn RTS/CTS and DTR/DCD signal lines on/off with the SHIFT and "E"/"F" key combinations.

[Transmission table setup display]

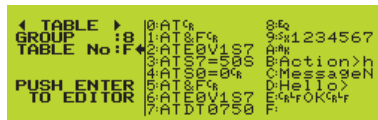

FLOW mode

Flow control can be simulated on the transmission and reception-lines using X-on/off flow control or the control line handshake. In the transmission mode, up to 16 cycles of data from transmission start until a generated interrupt request can be displayed. In the reception mode, you can set the number of received data cycles until a transmission interrupt request is generated, as well as the time until the transmission resume request is generated.

[Flow control test setup display]



ECHO mode

In the ECHO mode, LINEEYE protocol analyzers internally return received data. Buffer echo to send back data by a reception frame, character echo to send back data by a character and loop back echo that simply loops back data can be selected. It is used to test display terminals and communications terminals.

[ECHO mode setup display]

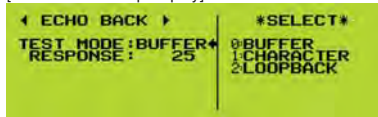

POLLING mode

The POLLING mode simulates the slave and master units in multidrop (1:N connection) polling protocols. In the slave mode, the LINEEYE protocol analyzers check the number of received frames that are assigned their address and whether errors occur or not, replying with user-set data. In the master mode, they send polling messages to 32 slave units, and check and display replies from each slave.

[Polling setup display]



Only for LE-3500R

BUFFER mode

In the BUFFER mode, you can select between transmission and reception, and send transmitted or received data that has been captured in the buffer using the unit's monitoring feature, as simulation data without requiring further manipulation. This mode is effective in conducting reproducibility tests using the same data as that monitored under actual communications conditions.

[Buffer data reproduction setup display]



Only for LE-3500R

PROGRAM mode

By creating a purpose-specific command program, the communications protocol can be flexibly simulated alongside condition monitoring. The program is created using the menu selection, so it is easy to master.

[Program example]



[PROGRAM mode commands]

Command	Operation
SEND CHR <input type="checkbox"/> <input type="checkbox"/> <input type="checkbox"/> <input type="checkbox"/> <input type="checkbox"/> <input type="checkbox"/> <input type="checkbox"/> <input type="checkbox"/>	Sends max. 8 data sets.
SEND REG <input type="checkbox"/>	Sends data registered in transmission table under specified REG No.
SEND BRK	Sends break signals (ASYN only).
WAIT CHR <input type="checkbox"/> <input type="checkbox"/> <input type="checkbox"/> <input type="checkbox"/> <input type="checkbox"/> <input type="checkbox"/> <input type="checkbox"/> <input type="checkbox"/>	Waits until receiving specified data (max. 8 data sets).
WAIT FRM	Waits until receiving 1 frame.
WAIT TM <input type="checkbox"/> <input type="checkbox"/> <input type="checkbox"/> <input type="checkbox"/>	Waits for specified amount of time.
GOTO L <input type="checkbox"/> <input type="checkbox"/> <input type="checkbox"/>	Jumps to specified label No.
CALL L <input type="checkbox"/> <input type="checkbox"/> <input type="checkbox"/>	Jumps to subroutine of specified label No.
IF CHR <input type="checkbox"/> <input type="checkbox"/> <input type="checkbox"/> <input type="checkbox"/> <input type="checkbox"/> <input type="checkbox"/> <input type="checkbox"/> <input type="checkbox"/> L <input type="checkbox"/> <input type="checkbox"/>	Branches if specified data in reception buffer.
IF LN <input type="checkbox"/> <input type="checkbox"/> <input type="checkbox"/> <input type="checkbox"/> <input type="checkbox"/> <input type="checkbox"/>	Branches if interface line is specified logic.
SET REG <input type="checkbox"/> <input type="checkbox"/> <input type="checkbox"/> <input type="checkbox"/> <input type="checkbox"/> <input type="checkbox"/>	Sets or increases/decreases value of specified REG No.
SET TM <input type="checkbox"/> <input type="checkbox"/> <input type="checkbox"/> <input type="checkbox"/> <input type="checkbox"/> <input type="checkbox"/>	Controls specified timer and sets to specified value.
INT TRG 0 <input type="checkbox"/> <input type="checkbox"/> <input type="checkbox"/>	Interrupts specified label when trigger 0 condition is satisfied.

Easy-to-Use Handy Functions Continue to Evolve

Firmware That Evolves

The latest firmware with additional functions and improvements can be found on our website. If you download it with your PC, you can then update to the latest version via a serial/USB cable.

Menu-based Simple Operation

Anyone can easily use LINEEYE protocol analyzers owing to the easy menu selection system handed down from earlier models.

[Top menu display (LE-3500R)]



[Top menu display (LE-2500R)]

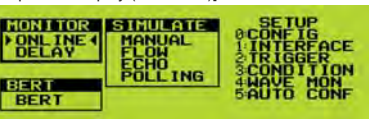

A backlit LCD makes it easy to view measurement data at night and in dark places.

Offline Analysis and Data Searches

Measurement data displays can be freely scrolled and paged. A powerful search feature allows you to locate specific data and perform counting.

Search key	Communications error (individual error type can be specified), communications data string of max. 8 characters (don't care and bit mask can also be specified), idle time beyond a specified duration, specific time stamp (don't care can also be specified), external trigger matching data
Search operations	Find and display, counting

[Example search key setting]



Using "don't care (*)", you can search for time stamp data from 10:30:00 to 10:39:59 as in this example.

Various Print Formats

Measured log data can be printed out in text format by the printer with indicated printing range or can be saved into a SD card or USB flash by the auto save function. The log file saved in a SD card or USB flash can be collectively* converted into a text file or a CSV file by connecting the media with a PC and capture data into the PC using the PC link software.

*The attached software (light edition, not the product version) can convert up to 3 files at the same time.

[Printout setting display]



You can select the output destination of the print data (text data).

[Remote control setting display]



According to the environment, you can select the modes for Wi-Fi connection.

[Wi-Fi AP mode setting display]



You can set the password and radio channel for the AP mode in which the analyzer turns to be an access point.

[Wi-Fi STATION mode setting display]

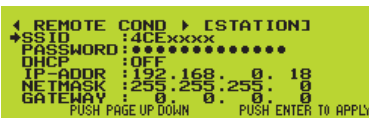

You can set the SSID and the password to connect the analyzer via an access point such as Wi-Fi router.

PC-compatible File Management Specification

Test conditions and results such as measured data can be saved on optional SD cards or USB flash in the files management format compatible with your PC. Of course, files can be interchangeably used* between models. Therefore, measurement data can be saved on-site with the LE-2500R, and analyzed or manipulated in greater detail using the LE-3500R back in the office.

* The LE-8200(A)/3500R/2500R/3500/2500/1500 are compatible in measurement data file. Part of files or data saved in higher hierarchy models or new models, however, may not be available to lower hierarchy models or conventional models.

Types, names, sizes and the date/time of files saved in the memory card can be checked.

[Example file operation display]



When many files have been saved, the file filter feature allows you to specify the type of file to be displayed.

[File filter setup display]



Auto RUN/STOP for Unmanned Measurement

By setting time and a date of measurement start and end, measurement can be done automatically during the specified time period. For example, measurement only for 3 hours from 18:00 to 21:00 every day is possible. Besides, if the power ON auto run function is used, unmanned measurement can be started automatically without pressing the RUN key after turning power ON.

[Example auto run display]



[Example statistical analysis printout]

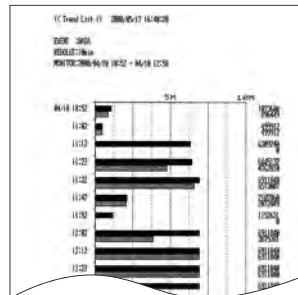

[Example logic analyzer waveform printout]

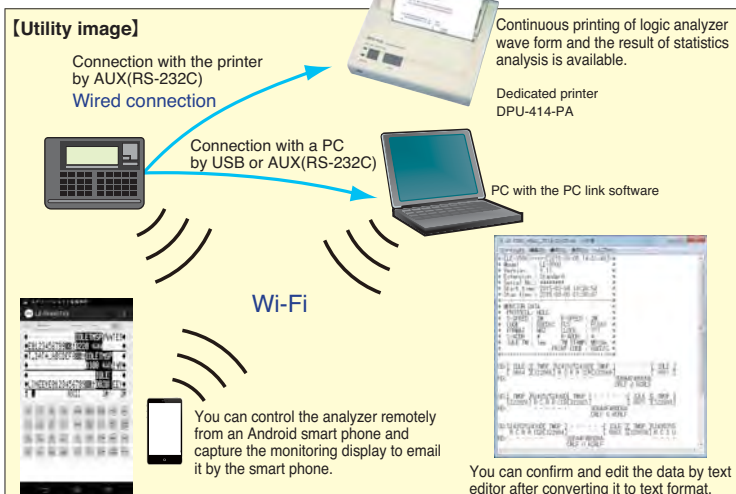
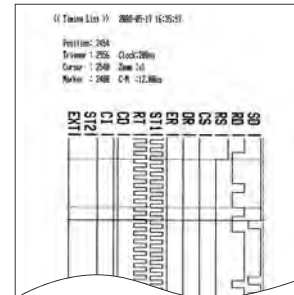

LE-PC300R Enhances the Link between Analyzers and your PC

PC Link Software **LE-PC300R**

- Cannot be used with OP-SB7GX
- The light edition of LE-PC300R is attached to LE-3500R/LE-2500R



Enables simultaneous control of multiple analyzers from a PC

The software supports the connection by USB, serial connection, and Ethernet connection by optional converter of Ethernet and serial. For LE-3500R/2500R, it also supports connection by Wi-Fi. It supports connection with multiple analyzers, displays and converts the measured data in the external memory such as SD card.

[USB/Serial connection, Wi-Fi connection, and External memory]

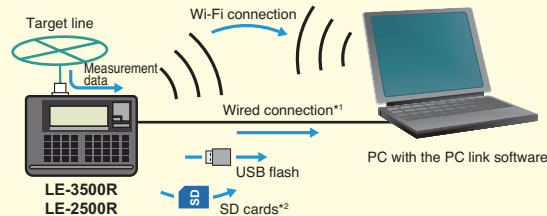

*1: Connected by a USB cable or AUX cable (LE2-8V)
*2: An interface to read the SD card is needed for PC.

[Linking multiple analyzers by USB, Wi-Fi and LAN]

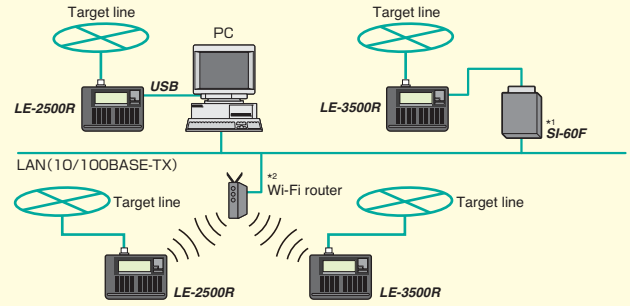

*1: SI-60F is a converter of Ethernet and serial which is supported by LE-PC300R.
*2: A Wi-Fi router of IEEE802.11 b/g/n is available.

Allows the measurement data to be checked on your large PC screen.



▲ Normal display

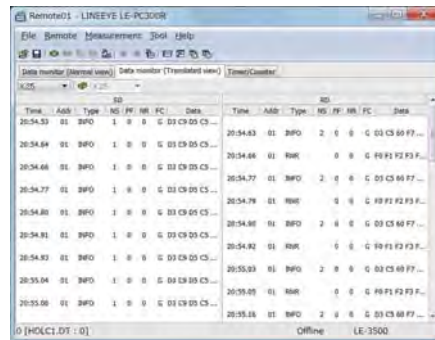

▲ HDLC translation display

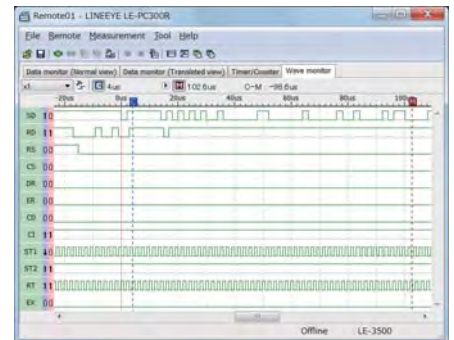

▲ Logic analyzer display

Records communication logs continuously on PC up to a maximum of 16GB

The remote monitor function allows to record the data measured by an analyzer on the HDD or SSD.

The fixed buffer mode and ring buffer mode are available. The former stops recording when the specified data size is reached, and the latter records data endlessly within the limit of the specified size.

*Measurement time is limited to 10 minutes for the light edition of LE-PC300R.

[Standard time for continuous recording on hard disk *1]

Target line speed *2	When 1 GB is specified : (e.g.: 1 MB x 1,000 files)	When 16 GB is specified : (e.g.: 8 MB x 2,000 files)
9600 bps	Approx. 60 hrs	Approx. 960 hrs
19200 bps	Approx. 30 hrs	Approx. 480 hrs
38400 bps	Approx. 15 hrs	Approx. 240 hrs

*1: In case of full-duplex communications line for transmission at 1 ms interval per 1 KB.

*2: Maximum communications speed that ensures recording of measurement data without failure will be about 1/5 of serial transfer speed between analyzer and PC.

Converts the recorded data to text format or CSV format all at once

Multiple files of communications logs can be converted to text or CSV format for use on word processor or spreadsheet. Conversion to text is based on the print format of the analyzer. In consideration of analysis on general search tool, it is possible to delete decorative guides or time data, and to specify conversion of sender or receiver data only.

* The number of the files which can be converted at the same time is limited to 3 for the light edition of LE-PC300R.

Changes the System Language Automatically

The system language alternates automatically between English and Japanese according to that of OS. This facilitates introduction of the software to development bases outside Japan.

LE-PC300R Specifications

Applicable analyzers	LE-3500R, LE-2500R, LE-3500, LE-2500, LE-1500	
Analyzer connection	USB, Wi-Fi, Serial, and Ethernet(optional unit SI-60/SI-60F is needed.)	
No. of analyzers to be connected	Multiple analyzers can be connected and controlled simultaneously.(No. of connectable analyzers depends on the performance of PC.)	
Key emulation function	Presents the analyzer's display on the PC screen to enable control in a manner as if operating the analyzer.	
Measurement condition setting	Measurement conditions (communications parameters, trigger and simulation data) can be input and edited on the dedicated window on PC screen.	
Remote monitor function	Starts/stops measurement with analyzer, displays the measurement data on PC screen, and records data continuously.	
	Recording modes	Fixed buffer mode (Records data up to the specified size) or ring buffer mode (Records data endlessly while leaving the latest data of the specified size) can be selected.
Recording capacity	Max. 16 GB can be specified up to 2,000 files in the unit of 1/2/4/8 MB data file.	
	Selectable among raw data, protocol translation and logic analyzer waveform.	
Display modes	Raw data	Displays communications data accompanied by idle time, time stamp and line status. Character code (10 kinds) and character size (small/medium/large) can be changed.
	Protocol translation	Translates and displays SDLC, X.25 and LAPD protocols. (Target protocols planned to be increased.)
	Logic analyzer waveform	Enlarges and reduces waveform, measures time between cursors, and rearranges signals.
Search function	Finds and displays the data that matches the search key.	
	Search key	Specified data string of max. 8 characters (don't care and bit mask can also be specified), idle time beyond a specified duration, specific time stamp (don't care can also be specified), error (parity, framing, BCC, break/abort, short frame: individual error type can be specified) external trigger matching data
Text-CSV conversion function	Specified number of recorded files can be converted to text or CSV format all together.	
Bitmap conversion function	Analyzer's display showing by key emulation can be saved to bitmap files.	
System requirements	Windows® 7/8/8.1/10	
Composition	CD (Software) x 1, instruction manual x 1, user registration card x 1	

PC Link Software for CAN/LIN

For OP-SB7GX **LE-PC7GX**



This software links your PC and LE-3500R/2500R equipped with CAN/LIN communications expansion kit OP-SB7GX. It enables to analyze collected CAN/LIN data on your PC.

- USB, Serial, Ethernet, and Wi-Fi* to the PC
- Key emulation function for remote control
- Record CAN/LIN data into the PC at maximum 16GB
- Display the specific ID frame at real time
- Data and timestamp search, text/CSV conversion
- Set the analyzer conditions from the software
- Read the measured file in the SD card or USB flash
- OS: OS: Windows® 7/8/8.1/10

*Version 2.00 or more of LE-PC7GX, OP-SB7GX, LE-3500R/2500R, and the Wi-Fi connection environment are needed.

Expanded communications

TTL/I²C/SPI IrDA/ASK CAN/LIN CC-Link

Optional measurement boards along with a variety of measurement cables expand the application range of the LE Series.



▲New communications standards different in hardware specification are supported with the replacement of the measurement board.

▲Cables and terminal adapters in a wide variety are available to meet the shapes of the connectors of measurement targets.
>> see page 12

TTL/I²C/SPI Communications Expansion Kit OP-SB5GL

OP-SB5GL is an expansion kit for communication of RS-232C(V.24) and TTL/CMOS signal level (1.8V - 5.0V). The measurement pod processes the signal, and the pod is connected with the analyzer by the relay cable. Thus it has 1 meter or more reach for a probe unit to the target than the TTL measurement port of LE-3500R/LE-2500R. Also it supports send/receive clock of USART communication which is not supported by TTL measurement port of LE-3500R/LE-2500R.

[I²C protocol setting screen]



[Example of I²C monitor display]

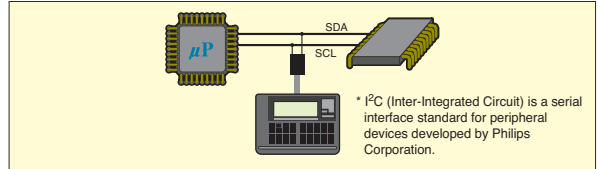
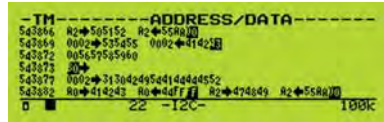

* I²C (Inter-Integrated Circuit) is a serial interface standard for peripheral devices developed by Philips Corporation.

Interface	RS-232C, TTL / CMOS (for I ² C and SPI)
Probe signal	SD (SDA/SDO), RD (SDI), RS (SS), CS, EX IN, SD CLK (SCL/SCK), RD CLK, Trigger IN, Trigger OUT [Lead length: 170mm]
Protocol	I ² C, SPI, BURST
Test function	Monitor / Simulation / BERT ⁽¹⁾
Baud Rate	It depends on the communication speed of the analyzer or the expansion firmware. For the simulation of I ² C, the rate is 50K, 100K, 200K, 384K, 417K or 1Mbps.
TTL/CMOS signal level	5.0V/3.3V/2.5V/1.8V signal levels can be selected.
Input Level	When 5.0V selected - High: minimum 3.5V, Low: max 1.5V When 3.3V selected - High: minimum 2.0V, Low: max 0.8V When 2.5V selected - High: minimum 1.7V, Low: max 0.7V When 1.8V selected - High: minimum 1.2V, Low: max 0.6V
Composition	Dedicated expansion board, relay cable, probe pod, prove unit

¹: BURST is available only for monitoring. I²C / SPI do not support BERT.

RS-530 Expansion Board OP-SB10N

OP-SB10N is an expansion board to equip LE-3500R / LE-2500R with a RS-530 port (Synchronous balanced communication such as X.21, RS-449, V.35). The RS-422/485 interface of LE-3500R/LE-2500R is terminal of 5 poles and does not have control lines for RS-422 while OP-SB10N has the control lines of RTS/CTS and DSR/DTR. With OP-SB10N, you can monitor/simulate the communication which needs these control lines.

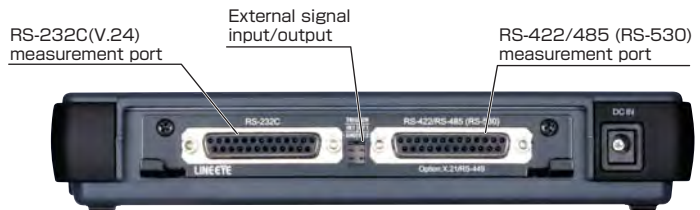
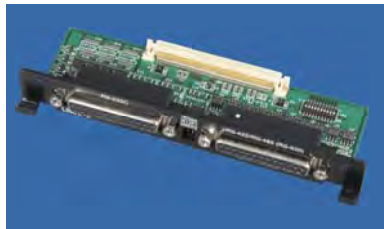

Interface	RS-232C(V.24), RS-422/485 (RS-530)
Test function	Monitor, Simulation, BERT
Composition	Expansion board

To use the following cables for LE-3500R/LE-2500R, OP-SB10N is needed. These cables are to be connected with the RS-422/485 (RS-530) connector of OP-SB10N.
>> see page12

Name	Model	Remarks
X.21 monitor cable	LE-25Y15	Y shape branch cable, DSUB 15pin for X.20/21
RS-449 monitor cable	LE-25Y37	Y shape branch cable, DSUB 37pin for RS-449
V.35 monitor cable	LE-25M34	Y shape branch cable, M shape 34pin for V.35
RS-530 cable	LE-25S530	Straight cable (shielded)

Current Loop Communication Expansion Kit OP-SB1C

OP-SB1C is an expansion kit for current loop communications which is presently used in the FA field and resistant to external noise. You can monitor the communication of current loop up to 60mA. You can also output communication data of current loop with passive and active (20mA/40mA).

Note : OP-1C, an adapter for current loop included in this kit can be purchased separately. If you have OP-SB5GL, with OP-1C you can use them as the same function that of OP-SB1C.

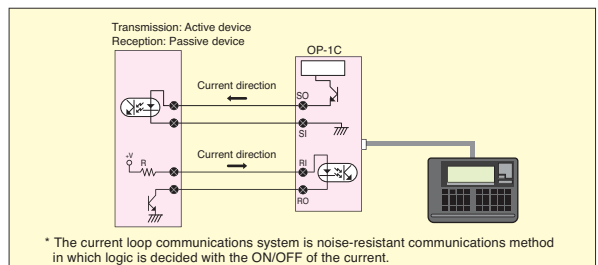

* The current loop communications system is noise-resistant communications method in which logic is decided with the ON/OFF of the current.

Interface	RS-232C, Current loop communications (4-pole terminal block)
Measurement signal	SD, RD
Baud rate (bps)	19.2 kbps max. ⁽¹⁾
Function	Monitor/Simulation
Monitor current level	10~60mA
Signal polarity	Normal/inversion ⁽²⁾
Simulation mode	Passive test and active test Active current: 20/40 mA (selectable with DIP switch)
OP-1C dimensions and mass	60(W) × 100(D) × 20(H)mm, Approx. 180g
OP-1C accessories	Dedicated expansion board, current loop adapter (OP-1C), relay cable [length : 800mm]

¹: The baud rate is restricted by the cable length and current value.

²: The signal polarity is set in the analyzer. (DIP switches for polarity switching equivalent to that of the conventional model, OP-1B, are not provided.)

Increases in the efficiency of developing and testing in-vehicle networks.

CAN/LIN Communications Expansion Kit OP-SB7GX

This expansion kit makes the measurement of up to 2 channels simultaneously by using Controller Area Network (CAN) communications used widely in FA systems and in-vehicle communications, and Local Interconnect Network (LIN) communications data in flexible connection. This expansion kit allows the simultaneous logic measurement and analog measurement of four-line external signals.

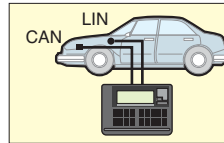

*CAN is the communications protocol for in-vehicle network developed by Robert Bosch GmbH. LIN is communications protocol for in-vehicle network proposed by automobile manufacturers in Europe.

CAN/LIN Simultaneous Monitoring

The OP-SB7GX enables the simultaneous measurement of CAN communications data and LIN communications data along with time stamp, thus contributing to the development of bridge units connecting the CAN and LIN. Furthermore, the ID filter can be used for highly efficient analysis.



[Example of CAN/LIN monitor display]

TM	CH	ID	TYP	DL	DATA	C	S	I
5227523	1	0010	DAT	8	013432334363637	0	0	0
5227524	2	1355-35	FRM	8	4040404050404154	85	0	0
5227541	1	0010	DAT	8	013432334363637	0	0	1
5227542	2	1355-11	FRM	8	023432334363637	0	0	1
5227543	1	0010	DAT	8	023432334363637	0	0	1
5227544	2	1355-16	FRM	8	0000	0	0	1

TM	Displays the time of frame reception completion in millisecond units (Example: 4216898 → Reception at 42 minutes 16.898 seconds) The [ZOOM/CODE] key can be used to select the display of the difference in time (dT) from the moment the previous frame is received.
CH	Reception channels (1: CH1 and 2: CH2)
ID	CAN: ID of received frame, LIN: Displays the following items in sequence. SynchBreak bit width, SynchField, "r" and ID (Example: 1355-35, SynchBreak width=13 bits, SynchField=55h, and ID=35h)
TYP	Types of reception frames DAT: CAN data frame REM: CAN remote frame ERR: CAN error frame FRM: LIN frame ILL: Illegal frames beyond LIN standards
DL	CAN: Contents of data length code (number of data bytes) LIN: Data length set for CONFIG for each ID
DATA	Contents of data field
C	Contents of LIN checksum (hexadecimal)
S	Displays whether or not the frame was normal.
I	Displays the logic of external signal IN1. All the external signals will be displayed with the [DISPLAY MODE] key.

CAN Simulation Function

A frame registered in the CAN data table is transmitted. A part of the data in the frame can be specified as sweep data that can be transmitted with the value of the data automatically changed from the initial value to the third target value, which makes it easy to check the response of the equipment according to the change of communications data.

[Settings for CAN data table]

DATA TABLE 1	*SELECT*
TYPE : DATA	0 DATA
ID : 234	1 EX-DATA
DATA : #BCDEF00000FF	2 REMOTE
REPEAT : 10	3 EX-REMOTE
INTERVAL : 11	
SWEEP : ON	

Sixteen frames specified with the number of repeating times and transmission intervals can be registered in advance.

[Image of sweep data settings]

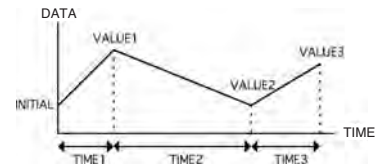

LIN Simulation Function

The OP-SB7GX in master mode can transmit the contents of the LIN data table in the order set in the schedule table repeatedly or according to key manipulation. A parity error, any number of break bits, and any SYNC data can be set to conduct confirmation tests for error data with ease. While in slave mode, the contents of the data table set with an ID conforming to the request of the master will be transmitted. Furthermore, the WakeUp signal (80h) can be transmitted at any time.

[Example of master mode settings]

LIN SIMULATE	*INPUT*
MODE : MASTER	SET
SYNCHIDSP : 0	INTER-
RESPONSP : 13	BYTE-
BYTE : 3	SPACE
	(0~99BIT)
	(DECIMAL)

A 15-bit response space (the space between the header block and response block) and 5-bit inter-byte space (the space between adjacent response data items) are set.

[Example of schedule table settings]

LIN SIMULATE	SCHEDULE TABLE			
No	TBL	PARITY	BREAK	SYNC
0	0	-	-	-
1	0	*	-	16
2	1	-	-	-
3	1	-	-	-
00-FF	: HEX			

Data table numbers 0, F, 1, and 2 are transmitted in sequence with a parity error set for an 18-bit-length BREAK signal for table F data.

Applicable analyzer	LE-3500R, LE-2500R, LE-3500, LE-2500
Interface	CAN: Conforms to ISO11898/ISO11519-2 standards (*) (DSUB9-pin connectors x 2) LIN: Conforms to ISO9141 standards (header 3-pin connector x 2)
Transceiver	CAN: Equivalent to TJA1050/1054 LIN: Equivalent to TJA1021
No. of measurement channels	2 channels in total with CAN, LIN or CAN / LIN in combination
Protocol	CAN2.0B, device net, LIN (Rev 1.1, 1.2, 1.3, 2.0 and 2.1)
Baud rate (bps)	CAN: 1 Mbps max. LIN: 26 kbps max. Arbitrary baud rate settings possible
Monitor function	ID filter possible and time stamp (1 ms min.) recordable CAN: Standard/Expansion format supported and possible to make bit timing settings LIN: Frame breaking possible according to the data length of each ID or specified idle time
Trigger function	Conditions: Specified communications data string (8 characters max.), specified remote frame (CAN), frame error (LIN), timer and counter coincidence, and external signal logic Operation: Measurement stop, saving in a memory card, timer control, counter control, specified data transmission, buzzer, and validation of trigger conditions
Simulation function	Pre-registered data is selected by key operation and transmitted (sweep transmission available) and Master and slave simulation (LIN only).
External signal input	Real-time display of 4-channel external signal state with LED possible. Signal logic recordable in synchronization with data continuous measurement of voltage possible. (Measurement range: ±15 V)
Composition	Dedicated expansion board, DB9 monitor cable x 2, 3-wire probe cable x 2, and 8-wire probe cable

*1: Settings in the Analyzer selectable with a relay.

High-speed HDLC/SPI Communications Firmware OP-FW10R

This expansion firmware increases the baud rates of bit synchronous communications (e.g., HDLC/SDLC/X.25, and CC-Link communications) and SPI communications up to 10 Mbps. The firmware processes main measurement items completely with a field programmable gate array (FPGA), thus precisely capturing communications data along with time stamps in 1-μs units. It is useful to measure the high-speed HDLC communication at CC-LINK of RS-485 multi-drop type, and the high-speed SPI/HDLC communications at TTL signal level on the PCB boards.



Applicable analyzer	LE-3500R
Interface	RS-422/RS-485, TTL, SPI
Protocol	HDLC, SDLC, X.25, CC-Link (NRZ/NRZI format, AR clock), SPI
Baud rate (bps)	Half-duplex 115.2 kbps ~ 10 Mbps Full duplex 115.2 kbps ~ 5 Mbps
Error check	FCS error (CRC-ITU-T), Abort, Short frame
Online monitor function	Time stamp 6 digits (0 to 524287) Resolution: 1ms, 100 μs, 10 μs, 1 μs units (selectable) ID filter (HDLC) 2 characters can be set (Don't care and Bit mask are available.)
Simulation function	Data table 16k data (can be divided into 16 parts and registered) MANUAL mode It transmits the registered data which corresponds with the key. Repeat transmission and repeat interval can be set.
Trigger function	Max 8 characters (Don't care and bit mask are available.). It automatically stops monitoring when it detects two pairs of single or sequential, an error, or low level of the external signal trigger input.
Data search function	Search of trigger data, error data, and character line are available.
Composition	Firmware CD-ROM, manual

[Screen for HDLC settings]

CONFIGURATION	*SELECT*
PROTOCOL : HDLC	156k 4-1M
RS-SPEED : 10M	256k 2-5M
CS-SPEED : 10M	512k 5H 10M
CODE : HEX	7-USER
FORMAT : NRZI	

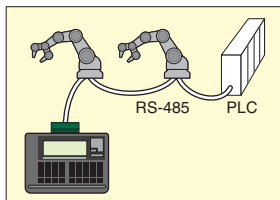

LE-3500R / LE-2500R Specifications

Model		LE-3500R	LE-2500R
Interface	RS-232C (V. 24)	○	○
	RS-422/485 ⁽¹⁾	○	○
	TTL/I ² C/SPI	○	○
Expansion measurement interface.	X. 20/21	○ [OP-SB10N + LE-25Y15]	○ [OP-SB10N + LE-25Y15]
	RS-449	○ [OP-SB10N + LE-25Y37]	○ [OP-SB10N + LE-25Y37]
	V. 35	○ [OP-SB10N + LE-25M34]	○ [OP-SB10N + LE-25M34] ⁽²⁾
	TTL(USART)	○ [OP-SB5GL]	○ [OP-SB5GL]
	Current loop	○ [OP-SB1C]	○ [OP-SB1C]
	CAN/LIN	○ [OP-SB7GX]	○ [OP-SB7GX]
Expansion firmware	High-speed HDLC/CC-Link	○ [OP-FW10R]	—
Standard Protocol	ASYNC (Asynchronous), ASYNC-PPP	○	○
	Character synchronous SYNC/BSC	○	○
	Bit synchronous HDLC/SDLC/X.25	○	○
	I ² C	○	○
	BURST ⁽³⁾	○	○
	Modbus	○	Not supported
	Optional Protocol	CC-Link	○
CAN		○	○
Devicenet		○	○
LIN		○	○
Synchronous clock	ST1 (DTE transmission clock), ST2 (DCE transmission clock), RT (DCE reception clock), AR (The synchronous clock extracted from the edge of the transmission and reception data)		
Capture memory	Memory capacity ⁽⁴⁾	64 MB	
	Added function with memory used	Two divided areas, data protection, and selection between fixed-size buffer and ring buffer, Auto save when finishing measurement.	
Baud rate	Max. speed (full-duplex)	2.048Mbps	1.000Mbps
	Max. speed (half-duplex)	2.048Mbps	1.000Mbps
	Speed setting range	50bps~2.048Mbps	50bps~1.000Mbps
	Speed setting step, accuracy	Freely set to four effective digits, separately for transmission and reception. (Margin of error: ±0.01% or less)	
Data format	NRZ, NRZI, FM0, FM1		
Data code	ASCII, EBCDIC, JIS7, JIS8, Baudot, Transcode, IPARS, EBCD, EBCDIK, HEX		
Character Framing	Asynchronous	Data bit (5, 6, 7, 8) + parity bit (0, 1) + stop bit (1, 2)	
	Character synchronous	Data bit + parity bit (6 or 8 bits in total)	
	Bit-oriented synchronous	Data bit (8 bits)	
Parity bit	NONE, ODD, EVEN, MARK, SPACE		
Multi-processor bit	MP (multiprocessor) bit is shown with a special mark.		
Bit transmission order	LSB first or MSB first (switchable)		
Polarity inversion	Normal or Inverted (switchable)		
Error check	For all protocols	Parity (ODD, EVEN, MARK, SPACE), Framing, Break, BCC (LRC, CRC-6, CRC-12, CRC-16, FCS-16, CRC-ITU-T, FCS-32), BCC permeation mode.	
	For bit-oriented synchronous protocol	Abort, short frame	
Online monitor functions	Specification	Communication log is recorded continuously and displayed in the LCD without affecting the communication lines.	
	Idle time display	OFF (no recording); Resolution: 100ms, 10ms, 1ms; Max 999.9 sec	
	Time stamp display	Date time stamp: Unit selectable among "Day/Hr/Min," "Hr/Min/Sec," "Min/Sec/10ms," or OFF (no recording)	
	Line status display	Records and displays the wave form of 4 signals (chosen from RS(RTS), CS(CTS), ER(DTR), DR(DSR), CD(DCD), CI(RI), EXIN(external trigger input) along with the transmission/reception data.	
	Address filter	Records only frames of the specified address. (only when HDLC/SDLC/X.25)	
	Data display and operations	Pause in capture, scroll, paging, jump to the specified screen.	
	Bit shift display	Entire frame can be shifted to the right or left in 1 bit increments.	
Protocol translation display	SDLC (modulo 8/128), ITU-T X.25 (modulo 8/128), LAPD, PPP, BSC, I ² C		
Line status LED	Target signals	Two color LEDs of SD, RD, RS(RTS), CS(CTS), ER(DTR), DR(DSR), CD(DCD), CI(RI), ST1(TXC1), ST2(TXC2), RT(RXC).	
	RS-232C	Logic ON (red) , logic OFF (green) , no connection NC (light off)	
	Other interface	Logic ON (red) , logic OFF or no connection NC (light off)	
Interval timer	2kinds; Max. count: 999999 (Resolution: 1ms, 10ms, 100ms)		
General-purpose counter	2kinds; Max. count: 999999		
Data counter	For SD and RD (1 each); Max. count: 4294967295		
Trigger function	Simultaneous detection conditions	Up to 4 pairs of trigger condition and action can be specified. Sequential actions, which validate another condition after one condition is satisfied, is also possible.	
	Trigger condition	Communication error (Parity, MP, framing, BCC, break, abort, short frame can be specified individually.), communication data string up to 8 characters (don't care and bit mask available), idle time more than the specified duration, match time/counter value, logic status of interface signal line and external trigger input	
	Trigger action	Stops measurement/test (offset can be set), validates trigger condition, controls timer (start/stop/restart), controls counter (count/clear), activates buzzer, saves monitor data on a memory card, sends the specified character string (during manual simulation), and sends pulse output to external trigger terminal OT2.	
	External trigger output	Sends pulse to external trigger terminal OT1 when all conditions are satisfied. Sends pulse to external trigger terminal OT2 according to the trigger output specification.	
Data search function	Specification	Retrieves the data with specific condition from capture memory.	
	Search condition	Communication error (parity, MP, framing, BCC, break, abort, short frame), communication data string up to 8 characters (don't care and bit mask available), idle time more than the specified duration, specified timestamp, and trigger matching data.	
	Search action	Shows the match data at the top or enumeration display (selectable)	
Monitor conditions auto setting	Measurement conditions such as protocol, transmission speed, (max. 115.2Kbps), data code, synchronous character and BCC check can be set ⁽⁵⁾ .		
Auto run/stop function	Enables measurement to start and end at the specified time at the selected repeating cycle (monthly, daily, hourly).		
Power ON auto run function	Enables measurement to start automatically after power is turned ON.		
Auto save function	Specification	Automatically saves the monitored data in the capture memory and saves as communications log file in a SD card or USB flash.	
	File size	BUF (capture memory size), 1MB, 2MB, 4MB, 8MB, 16MB, 32MB	
Max. files	1024		

Model	LE-3500R	LE-2500R
Delay time function	Measures and displays the interval of change in the interface signal line. (current/min/max/average, resolution: 0.1ms)	
Signal voltage measuring function	Measures and displays the value of voltage amplitude: SD, RD, ER (DTR), and CD (DCD) over RS-232C (current/min/max, range ±15V (RS-232C), ±5.5V (TTL)).	
Statistical analysis function	Takes statistics and displays graphs of transmission/reception data count, number of frames, and satisfied trigger condition count.	Not available
Logic analyzer function	Specification	Measures the logical change of the interface signal in the sampling clock period, and displays its wave.
	Sampling clock	1KHz to 20MHz (14 steps)
	Sampling memory	Min 2,000
	Trigger condition	Trigger conditions in the ONLINE monitor functions match. Logical status of interface signal or external signal match.
	Trigger position	Before, center, after
	Zoom in/out	×8, ×4, ×2, ×1, ×1/2, ×1/4, ×1/8, ×1/16, ×1/32, ×1/64
	Other functions	Time measurement by cursor, signal line exchange, signal status search
BERT (bit error rate test)	Specification	Conforming to ITU-T G.821 it measures line quality such bit error rate and block error rate ⁽⁶⁾ .
	Communication mode	Synchronous (SYNC), Asynchronous (ASYNC) RTS/CTS flow control is available.
	Measuring speed	50bps~2.048Mbps, freely set to four effective digits
	Measurement mode	Continuous measurement, specifies the number of receiving bit, specifies the time to measure, repeatedly measurement at the unit of 1 - 1440minutes
	Test pattern	2 ⁿ -1, 2 ⁿ⁻¹ , 2 ⁿ⁻¹ -1, MARK, SPACE, ALT, DBL-ALT, 3in24, 1in16, 1in8, 1in4
	Error bit insertion	Inserts 1-bit or 5-bit error in test pattern by key operation.
	Measurement range	It is able to measure the parameter of the ITU-T advice G.821. It is able to output the external trigger by detecting the error bit. Effective received bit (0~9999999), bit errors (0 to 9999999 to 9.99E9), bit error rate(0 to 9.99E-9 to 1), block errors (0 to 9999999 to 9.99E9), block error rate (0 to 9.99E-9 to 1), Savail(available measurement time: 0 to 9999999sec), loss count (synch loss: 0 to 9999), error duration (0 to 9999999sec), %EFS (normal operation rate: 0.000 to 100.000%)
Simulation function	Specification	Enables transmission/reception test of any given data in DTE or DCE mode (selectable).
	Transmission data entry	Register 160 kinds of transmission data tables (10 groups x 16, total 16K data)
	Error data entry	A part of transmission data can be registered as error data such as parity error.
	Line control mode	Auto Controls transmission timing with RS(RTS), CS(CTS), ER(DTR), CD(DCD) signal lines automatically in 1 ms increments or manual (key operation) can be selected.
	Transmission driver control	Auto control turning ON driver only during data transmission or manual mode linking with ER (DTR) or CD (DCD) key operation can be selected during simulation of RS-485.
MANUAL mode (Manual test)	Sends the data assigned to operation keys each time a key is pressed, while checking communications status on the display. Can be used together with the trigger function.	
FLOW mode (Flow control test)	Simulates the X-on /X-off control data and flow control procedures of RTS/CTS control line. (Sender and receiver selectable). ⁽⁷⁾	
ECHO mode (Echo test)	Sends the received data frame by frame (buffer echo), by data (character echo) or by loop back.	
POLLING mode (Multi-polling test)	Simulates multi-polling communications procedures. (Slave and master selectable)	
BUFFER mode (Buffer transmission test)	Reproduces transmission of selected data (SD or RD) captured in memory by monitor function.	Not available
PROGRAM mode (Program simulation)	Creates a simulation program (Max. type: 4, Max steps: 512) using the dedicated commands (37 types) to test the communication procedure.	Not available
File management function	Specification	Measurement data and condition can be saved in a SD card or USB flash. And the formatted data/condition can be used in the PC.
	File types	Measurement data (.DT), all measurement conditions (.SU), trigger save data (TG SAVEnn.DT), and auto save data (#nnnnnnn.DT)
	File operations	Normal file display, file display by specified type/created date basis, save, load, delete, delete all, and format
	Max. capacity ⁽⁸⁾	32 GB
Printout function	Specified range of measurement data can be continuously printed in format corresponding to the display mode. Displayed images can be printed to make hard copies.	
LCD	Monochrome 240 x 64 dots with backlight	
Remote control	PC link software (light edition) ⁽⁹⁾ is attached. The library to control the analyzer is available. Application for Android smart phone " LE-REMOTe4 " is available.	
AUX(RS-232C) port	Mini DIN8 pin connector. Communication speed: 9600bps to 230.4Kbps (6 steps) Print out data, Can be used with PC [LE-PC300R], Can be used to upgrade the firmware.	
USB2.0 device port	B-connector in device side. Transfer data in High speed. Can be used with PC [LE-PC300R], Can be used to upgrade the firmware.	
USB2.0 host port	A-connector on the host side for USB flash connection, it transfers data in High speed.	
Wi-Fi connection ⁽¹⁰⁾	802.11 b/g/n for PC connection, used for LE-PC300R. STA mode (via an access point) and AP mode (directly with a PC) are selectable.	
External power supply	Provided AC adapter Input: 100 to 240 VAC at 50/60Hz	
Built-in battery	Nickel hydrogen battery (Model: P-19S), Battery operating time ⁽¹¹⁾ : About 7 hours, Battery Charging time: About 2.5hours	
Temperature range	In operation : 0 to 40 degrees, In storage : -10 to 50 degrees	
Humidity range	85% (RH) max.	
Standard	CE(class A), EMC(EN61326-1 : 2013)	
Dimensions	210 (W) x 154 (D) x 38 (H) mm	
Mass	About 760g	
Accessories	Monitor cable for DSUB 25-pin (LE-25M1), Monitor cable for DSUB 9-pin (LE-009M1), DSUB25pin-9pin conversion adapter (LE-259AD), 5 wires TTL prove cable (LE-5LS), USB cable, AC adapter (6A-181WP09), carrying bag (LEB-01), Utility CD, instruction manual and warranty	

⊙: Standard support. ○: Supported with option product in [].

*1: To monitor control line, expansion board "OP-SB10N" (which has RS-530 port) is needed. *2: The control signal lines of V.35 are not supported. *3: This mode is used to capture all data in synchronization with clock edges. *4: Transmission/reception data, idle time, time stamp, and line status items consume 4 bytes of memory at each capture. *5: This function supports only ASYNC, SYNC/BSC, HDLC/SDLC. Correct auto settings are impossible if the amount of communications data is small or communications data includes a large number of errors. *6: Only ASYNC mode and SYNC mode are available. *7: Only ASYNC is available. *8: Only the SD cards purchased from LINEEYE are supported. *9: This is the light edition of optional product "LE-PC300R" (with some limitation for its functions). *10: Wi-Fi function is available only in Japan, USA, and Canada. *11: The battery operating time was measured under LINEEYE's measurement conditions with the LCD backlight turned OFF.

Order Information

- LE-3500R/LE-2500R (Comes with Japanese manual.)
- LE-3500R-E/LE-2500R-E (Comes with English manual.)

Standard Set



- Portable communication analyzer 1
- DSUB 25-pin monitor cable (LE-25M1) 1
- DSUB 9-pin monitor cable (LE-009M1) 1
- Conversion adapter for DSUB 25-pin to DSUB 9-pin (LE259-AD) 1
- TTL prove cable (LE-5LS) 1
- USB cable 1
- AC adapter (6A-181WP09) 1
- Carrying bag (LEB-01) 1
- Utility CD (the light edition of PC link software is included.) ... 1
- Instruction manual 1
- Warranty 1



Options for LE-3500 LE-2500

Cables / Terminal blocks / Converter



Monitor cable for DSUB 25-pin
LE-25M1
Branch cable for monitoring communication lines over general DSUB 25-pin.

1.5m 0.1m

DB25(Male) DB25(Male) DB25(Female)

*Same as the cable packed with analyzer.



Monitor cable for DSUB 9-pin
LE-259M1
Branch cable for measuring RS-232C over DSUB 9-pin of PC, etc.

1.5m 0.2m

DB25(Male) DB9(Female) DB9(Male)



Conversion adapter for DSUB 25-pin to DSUB 9-pin
LE-259AD
It converts DSUB 25-pin of RS-232C to DSUB 9-pin. Using with LE-009M1 it is equivalent with LE-259M1.
DB25(male) - DB9(female)
*Same as the one included in the accessories of LE-3500R/LE-2500R.



X.21 Monitor cable
LE-25Y15
Branch cable for measuring X.20/21 over DSUB 15-pin. (Shield type)

1.2m

DB25(Male) DB15(Male) DB15(Female)



RS-449 Monitor cable
LE-25Y37
Branch cable for measuring RS-449 over DSUB 37-pin. (Shield type)

1.2m

DB25(Male) DB37(Male) DB37(Female)



5 wires TTL probe cable
LE-5LS
This is the probe cable which is compatible with the 5-pins TTL measurement port and external trigger terminal of LE-3500R/LE-2500R. The cable length is 350mm.
*Same as the one included in the accessories of LE-3500R/LE-2500R.



V.35 Monitor cable
LE-25M34
Branch cable for measuring V.35 over M34-pin.

1.5m

DB25(Male) M34(Male) M34(Female)



RS-530 cable
LE-25S530
A twisted pair cable for RS-530(shield type)

1.5m

DB25(Male) DB25(Male)



AUX cable for DSUB 9-pin
LE-28V
Cable for connection AUX (RS-232C) port of an analyzer with PC (DSUB 9-pin DTE specification).
* Length:2.5m
*Same as the cable packed with analyzer.



DSUB 9-pin monitor cable
LE-009M1
This is the branch cable for DSUB 9-pin.
*Same as the one included in the accessories of LE-3500R/LE-2500R, and OP-SB7GX.

1.5m 0.1m

DB9(Male) DB9(Female) DB9(Male)

Memory card



32GB SDHC card
SD-32GX
The SD-card which is confirmed to operate for LINEEYE analyzer
Supported model: LE-3500R
*The image is for illustration purposes.



16GB SDHC card
SD-16GX
The SD-card which is confirmed to operate for LINEEYE analyzer
Supported model: LE-3500R, LE-2500R
*The image is for illustration purposes.

Carrying bag



Carrying bag
LEB-01
Bag with pockets for storing and carrying accessories such as AC adapter, cables, etc.
*Same as the carrying bag packed with analyzer.

AC Adapter



Wide input AC adapter
6A-181WP09
Input: AC100~240V, 50/60Hz
Output: DC9V, 2A
Plug: center ⊕
*Same as the AC adapter packed with analyzer.

Battery pack

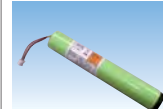

NiMH battery pack for replacement
P-19S
Rating: 4.8V, 1900mAh
Applicable model: LE-3500R, LE-2500R, LE-3500, LE-2500, LE-1500, LE-7200, LE-3200, LE-2200, LE-1200
*An auxiliary and replacement battery equivalent to the Analyzer built-in battery.

Compact thermal Printer **RoHS**

Compact thermal printer
DPU-414-51B-E
Built-in battery, dedicated roll paper (x1) included.
*AC adapter and cable are not prepared. Provide them separately.

Compact Thermal Printer Set
DPU-414-PA
Includes printer (DPU-414-51B-E), roll paper x1, AC adapter, and printer cable (LE2-8P).

Handy thermal printer for on-site printout of measurements

- Prints 40 digits per line in normal mode and 80 digits in reduced mode.
- High-speed printing at 52.5 characters per second.
- Incorporates eco-friendly NiMH battery.
- Supports Centronics parallel and RS-232C ports.
- Dimensions: 160(W)x 170(D)x 67(H)mm
- Weight: Approx. 690g (including built-in NiMH battery)



Options
AC adapter for DPU-414
PW-C0725-W2
Input: AC100V~240V
Output: DC7.0V, 2.5A(center ⊖)
Roll paper
TP-411L
Thermal roll paper for DPU-414.
10 rolls per carton.
Width: 112mm Length per roll: Approx. 28m
Battery pack for DPU-414
BP-4005-E
Same as NiMH battery built-in DPU-414-51B-E.
4.8V, 1100mAh
AUX cable for DPU-414
LE2-8P
This is a cable to connect AUX (RS-232C) port of the analyzer with the serial port of DPU-414.
The length is 1.5m.

MULTI PROTOCOL ANALYZER **LE-8200A/LE-8200**

Sister Product



240 (W) x 190 (D) x 48 (H) mm, about 1.1kg

The top-level model of battery-powered portable communications analyzer with wide color display.

- Measurement at Low to Mega Speed up to 4Mbps.
- 100 Mbytes capture memory.
- Supports to TTL, I²C, SPI, CAN, LIN, FlexRay, LAN and USB.
- A long recording time of communications logs on 128GB CF card or USB flash drive (*1).
- Logic analyzer function and analog waveform analysis (*2).
- A compact and lightweight model in B5 size operating continuously for 4 hours.

*1 USB flash is supported only by LE-8200A. *2 High-speed analog waveform analysis requires an optional device.

- All brand names and product names mentioned in this catalog are trademarks or registered trademarks of their respective companies.
 - Specifications and designs of products listed in this catalog are as of June 2017, and are subject to change without notice for improvement.
 - Colors of actual products may differ slightly from that listed due to printing condition.
 - This catalog may not be reprinted or duplicated, in part or in whole.
- ©2017 by LINEEYE CO., LTD.



SAFETY WARNING
Read the instruction manual provided with the product before use and use the product as explained in that manual. Using the product in ways not guaranteed in the manual, connecting it to systems outside of the specified ranges and remodeling can all cause trouble and damage. LINEEYE CO., LTD. will assume no responsibility whatsoever for trouble or damage arising because of unauthorized ways of use.

LINEEYE CO., LTD.

■ Head Office/Sales Office
Marufuku Bldg 4F, 39-1 Karahashi Nishihiragaki-cho, Minami-ku, Kyoto, 601-8468
PHONE: 81-75-693-0161 FAX: 81-75-693-0163

● URL <http://www.lineeye.com>

● E-mail : info@lineeye.co.jp

* LINEEYE CO. LTD. is a venture company founded by electronic equipment development members of the former Sekisui Chemical Co., Ltd. with investment from the Sekisui Venture Fund. The electronic equipment business of Sekisui Electronic Co. Ltd. was transferred to LINEEYE CO. LTD. in October 2000.