OPTIONAL KIT
FOR MULTI PROTOCOL ANALYZER

Expansion set for the current loop communication

OP-SB85C/OP-SB1C

Adapter for the current loop communication

OP-1C

Instruction Manual

Instruction

Thank you for your purchase of OP-SB85C / OP-SB1C / OP-1C.

To use it correctly, you are advised to read and understand this instruction manual thoroughly. Keep this together with the warranty. If you encounter any problems, you will find helpful information in this manual.

NOTICE

It is prohibited to reprint or duplicate any part of the whole of this instruction manual without prior permission from LINEEYE.

The content of this instruction manual and specifications of the products are subject to change without any notice.

This instruction manual has been designed and edited with great care to give you all necessary information. If you have any questions, feel free to direct your inquiries to LINEEYE.

LINEEYE makes no warranty or guarantee, either expressed or implied with respect to its quality, performance, merchantability, or fitness for a particular purpose. LINEEYE shall not be liable for direct, in-direct, special, incidental, or consequential damages resulting from any defect in the product. The warranty and remedies set forth above are exclusive and in lieu of all others.

USER LIMITATION

This product has been developed for the purpose of using as an analyzer only.

When you use this product with the following devices that are required to function with a high degree of reliability, safety and accuracy, use it under considering the safe design of the system in order to maintain reliability and safety for that system;

- *Devices that are directly related to transportation such as airplanes, trains, cars etc.
- *Devices for crime prevention and disaster privension.
- *Each kind of safety devices and so on.

This product has not been developed for the use that needs exclusively high reliability and safety:

aerospace apparatus, trunk communication apparatus, nuclear control apparatus, medical apparatus related with life maintenance etc. Therefore, do no use for those purposes.

Safety Information

Read this first !!





Here, the important content has been described, for preventing the people who will use the object products and other people from being damaged and preventing damage of properties, and for using safely and correctly.

Before using, please read the main contents after you understand the following contents (symbols & marks).

 **Warning** Should the device be used without following these symbols, there is a possibility of accidents, such as a death or a serious injury, occurring.

 **Caution** Should the device be used without following these symbols, there is a possibility of accidents, such as a injury , and material damage occurring.

Warning

	<ul style="list-style-type: none">● Stop using the analyzer immediately when smoke or smells emanate from itself. Continuous use may result in an electric shock, a burn and/or fire.
	<ul style="list-style-type: none">● Stop using the analyzer when a liquid or foreign substance get into the analyzer. This may result in an electric shock or fire. → Immediately switch off the analyzer and unplug it.
	<ul style="list-style-type: none">● Do not disassemble, modify or repair analyzer. This may result in a injury, an electric shock, fire, explosion and/or a breakdown due to overheating.
	<ul style="list-style-type: none">● Do not put the analyzer in fire or heat them. This may result in a injury and fire due to overheating or explosion.

Caution

	<ul style="list-style-type: none">● Do not leave the analyzer in the following conditions. Strong magnetic field, static electricity or dusty place. Temperature and humidity above the specification. Condenscendingly place. Not flat, or shaking place. Place with leaking water or electricity. Place affected by direct sun or near the fire .
--	---

Chapter 1 Before Using the Product

1.1 Overview

This option is the expansion board set used with the protocol analyzer for monitoring, send/receive test, and BERT of the current loop communication.

Model	Applicable Analyzer	Remarks
OP-1C	LE-1100/LE-2100/LE-3100	To be connected directly to the option port
	LE-7000 ^{*1}	To be connected to the separately-sold interface board
	LE-1200/LE-2200/LE-3200/LE-7200 ^{*2}	
OP-SB1C	LE-1500/LE-2500/LE-3500	Set product which includes OP-1C and the interface board
	LE-1500R/LE-2500R/LE-3500R	
	LE-2500XR/LE-3500XR	
OP-SB85C	LE-8200/LE-8200A	Set product which includes OP-1C and the interface board

*1 : The interface board (included in OP-SB5C, discontinued product) is needed.

*2 : The interface board (included in SB-20L, OP-SB5F, or OP-SB6F - discontinued products) is needed.

1.2 Unpacking

When you unpack the product, make sure of the following:

- The product has not been damaged during transportation.
- You have received all the standard accessories listed below.

-----OP-1C-----		-----OP-SB1C / OP-SB85C-----	
<input type="checkbox"/> Adapter for the current loop	1	<input type="checkbox"/> Adapter for the current loop	1
<input type="checkbox"/> Relay Cable	1	<input type="checkbox"/> Interface Board*1	1
<input type="checkbox"/> Instruction Manual (This book)	1	<input type="checkbox"/> Relay Cable	1
<input type="checkbox"/> Customer Registration Card / Warranty	1	<input type="checkbox"/> Instruction Manual (This book)	1
		<input type="checkbox"/> Customer Registration Card / Warranty	1

*1 : The type of board is different between OP-SB1C and OP-SB85C.

Please contact your LINEEYE distributors if you find any damage to the product caused by transportation, or if there are accessories lacking.

1.3 Installation of Firmware

As the standard firmware of the analyzer supports this option, you do not need to install any other firmware to use it.

The latest version of the standard firmware is available on LINEEYE website (https://www.lineeye.com/html/download_update.html). Please refer to the manual of the analyzer for how to update it.

1.4 Appearance of the Adapter

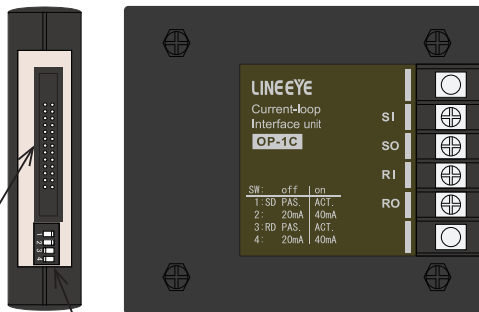

The connector for relay cable Dip switch

7.62 ~ 7.62mm pitch, M3 screw terminal

1.5 Behavior as a Passive / Active device

At the simulation mode (in which the analyzer sends data) and the BERT, you can change the behavior of the analyzer between passive mode (which uses the power for current loop from an external power source) and the active mode (which uses the constant current circuit of this adapter).

→ 「2.2 Setting of Dip Switch」

Circuit block diagram of Input/Output

<Passive>

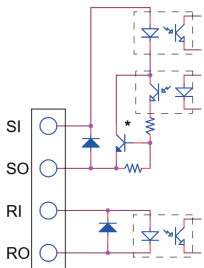

<Active>

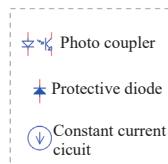
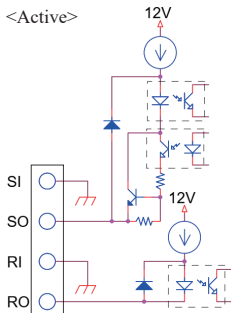

*: When monitoring, the transistor is always on.

Chapter 2 Basic Operation

2.1 Connection

□ In the case of using LE-8200A/LE-8200

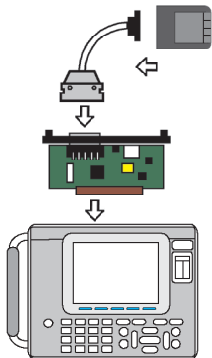

■ Take a look at a graphics image on the left.

1. To exchange the interface board inserted in your analyzer with the interface expansion board (OP-SB85C, OP-SB85 or OP-SB85IR *1), follow the instructions.

1) Turn off your analyzer.

2) Screw off the M3 screws on the expansion slot of your analyzer.

3) Take the board off pulling the handles of the interface board.

4) Insert the interface expansion board (OP-SB85C, OP-SB85 or OP-SB85IR) into the slot completely.

5) Screw it on using M3 screws.

2. Connect the adapter of current loop to the relay cable.

*1 Able to use the expansion board of OP-SB85L/85/85IR.

□ In the case of using LE-3500XR/LE-2500XR/LE-3500R/LE-2500R/LE-1500R

When you use the product with LE-3500R/LE-2500R/LE-1500R, follow the direction for LE-8200/LE-8200A(above) by inserting interface sub-board included in the OP-SB1C package and connect the adapter for current loop.

□ In the case of using LE-3500/LE-2500/LE-1500

Connect OP-1C to the interface board*2 following the same procedure of LE-8200A/8200.

*2 Use the expansion board (SB-25L) of OP-SB5GL/OP-SB5G or OP-SB6G.

□ In the case of using LE-7200/LE-3200/LE-2200/LE-1200

Connect OP-1C to the interface board*3 following the same procedure of LE-8200A/8200.

*3 Use the expansion board (SB-20L) of OP-SB5F or OP-SB6F.

2.2 Setting of Dip Switch

Set the dip switch of the adapter of current loop following the test condition.

Switch No.		OFF	ON	
1	SD side	Passive	Active	*1
2		20mA supply	40mA supply	*2
3	RD side	Passive	Active	*1
4		20mA supply	40mA supply	*2

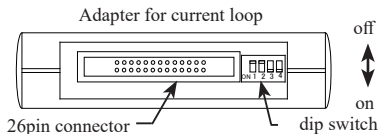

*1 : Set OFF for monitoring.

*2 : The value of current loop is available, only when "Active" is selected.

2.3 Connection and Setting for Monitoring

1. Setting of dip switch:

Set OFF the dip switch No.1 and 3 of the adapter.

2. Connection when monitoring the current loop between terminals A and B is monitored:

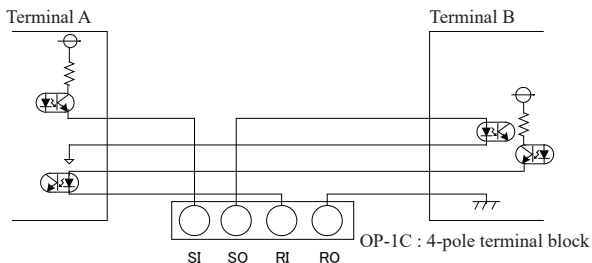

2.4 Connection and Setting for Simulation (active type)

1. Setting of dip switch:

Set ON the dip switch No.1 and 3 of the adapter to make the motion type "Active."

2. Connection to the passive type of the current loop device:

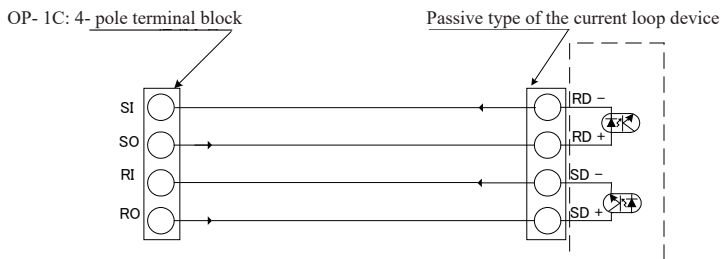

2.5 Connection and Setting for Simulation (passive type motion)

1. Setting of dip switch:

Set OFF the dip switch No.1 and 3 of the adapter to make the motion type “Passive.”

2. Connection to the current loop device

a. Connection to the active type of the current loop device

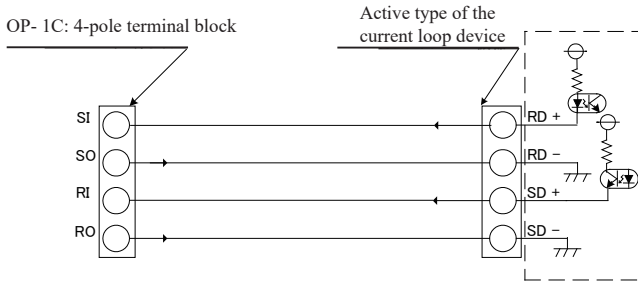

b. Connection to the passive type of the current loop device

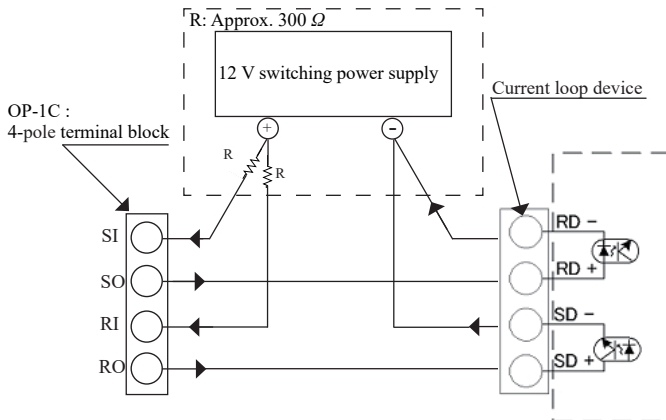

Signals (current) are supplied by ON/OFF operations of the phototransistors on the SI and SO sides of the OP-1C.

2.6 Setting of Analyzer

■Setting of the Interface Board

□In the case of using LE-8200A/LE-8200:

Select “1: Interface” at the top menu and set the “Polarity” item to “Normal” or “Invert”. Other setting items such as “Level” do not affect the operation, thus they are not needed to be changed.

	space	mark
Normal	Current ON	Current OFF
	LED ON	LED OFF
Invert	Current OFF	Current ON
	LED OFF	LED ON

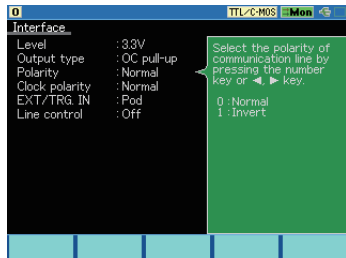

□In the case of LE-3500XR/LE-2500XR:

Select “Interface” at the top menu and set the “Measurement port” item to “OPTION” and then set the “Polarity” item to “Normal” or “Invert”. Other setting items such as “Output type” do not affect the operation, thus they are not needed to be changed.

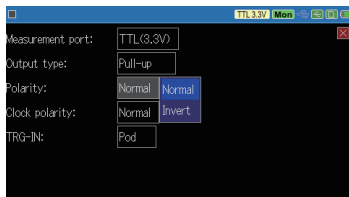

□In the case of the other models:

Select “1: Interface” at the top menu and set the “PORT” item to “OPTION” and then set the “Polarity” item to “NORMAL” or “INVERT”. Other setting items such as “LEVEL” do not affect the operation, thus they are not needed to be changed.

1: INTERFACE	OPTION	#SELECT#
PORT	OPTION	0: NORMAL
LEVEL	3.3V	1: INVERT
OUTPUT	PUP	
POLARITY	NORMAL	
CLK POLA	NORMAL	
TRG IN	POD	

Current-Loop Current	Polarity	Remark
The current runs when there is a communication data.	Normal	Generally used for a to 1 communication
The current runs when there is no a communication.	Invert	Generally used for a communication of multi-drop connection

■Basic communication conditions setting

Press [0] at the top menu, and set the items such as communication speed, data bit, parity bit, etc. at the basic communication condition setting screen (configuration screen).

< An example of Le-3500XR >

Protocol	ASYNC
Speed	9600 bps
Data code	ASCII
Data bit	8bit
Parity	None
Stop bit	1bit

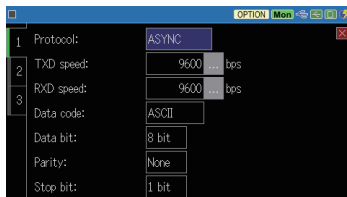

Chapter 3 Monitor and Simulation

3.1 Monitor Function

Start monitoring:

Move “▶◀” to “ONLINE” in “Monitor” and press [RUN].

The analyzer starts monitoring, and it displays the data on the screen, and saves data in the Capture Buffer.

☰ To learn more details about the monitor, read the instruction manual of analyzer.

3.2 Simulation Function (data transmission)

1. Register the transmission data:

Move “▶◀” to “MANUAL” in “Simulation” and press “9 : Data Send Table” to register the transmission data.

2. Start simulation function:

Move “▶◀” to “MANUAL” in “Simulation” and press [RUN].

3. Transmit the registered data

Press the key ([0] to [F]) to send data, which corresponds with the same number of the data table.

☰ To learn more details about the simulation, read the instruction manual of analyzer.

3.3 Data Display

☐ In the case of using LE-8200

```
0 0 ASCII DTE
SD TMSP Fk 0 1 2 3 4 5 6 7 8 9 A B C D E F G H
RD 00001.311.0
SD I J K L M N O P Q R S T U V W X Y Z Fk TMSP
RD 00001.537.8
SD
RD ? 1 2 3 4 5 6 7 8 9 A B C D E F G H I J K L M N O
SD TMSP Fk 0 1 2 3 4
RD P Q R S T U V W X Y Z Fk Lf 00001.811.0
SD 5 6 7 8 9 A B C D E F G H I J K L M N O P Q R S T
RD
SD U V W X Y Z Fk TMSP
RD 00001.953.4 0 1 2 3 4 5 6 7 8 9 A B
SD
RD C D E F G H I J K L M N O P Q R S T U V W X Y Z Fk
SD TMSP Fk
RD Lf 00003.137.8 0 1 2 3 4 5 6 7 8 9 A B C D E F G H
SD
RD I J K L M N O P Q R S T U V W X Y Z Fk Lf
Change data code Display control
```

SD (Data in the upper screen)

Monitor : Monitored data in the SD side.

Simulation : Transmission data of the analyzer

RD (Data in the lower screen)

Monitor : Monitored data in the RD side.

Simulation : Transmission data of the target device.

□ In the case of using the analyzers other than LE-3500XR/LE2500XR

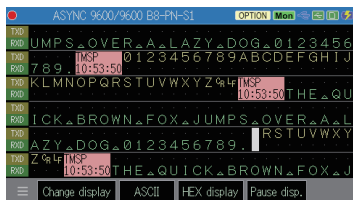

(Data in the upper screen)

Monitor : Monitored data in the SD side

Simulation : Transmission data of the analyzer

(Data in the lower screen)

Monitor : Monitored data in the RD side

Simulation : Transmission data of the target device

3.4 Simple Loop Back Test (self-diagnosis test)

The simple loop back test is done, when you want to confirm the performance of OP-1C/OP-SB85C/OP-SB1C.

Figure 1. Connection of loop back

Table 1. Communication condition of loop back test

OP-1C: 4-pole terminal block

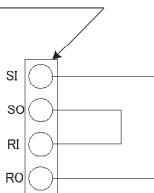

Protocol	ASYNC
Speed	9600 bps
Data code	ASCII
Data bit	8bit
Parity	None
Stop bit	1bit

1. Set ON the dip switch No.1 and set OFF the dip switch No.3 of the current loop adapter. (SD side is on active and RD side is on passive.)
2. Connection of loop back is set as figure1.
3. Set the communication condition of the analyzer according to Table 1.
4. Send the data in the same process as "3.2 Simulation Function". And confirm that the received data is same as the transmission data at the display.

Chapter 4 Analog Wave Monitor Function

Analog wave monitor function measures the voltage value (range: $\pm 12\text{V}$) with the time resolution (max 25nsec), using the 3 line probe cable.

*To use this function, you need to have LE-8200A/LE-8200 and the expansion board (OP-SB85 series).

4.1 Connection

1. Connect the 3 line probe cable to the expansion board like the figure.
2. Pick the measuring object using the 3 line probe cable.

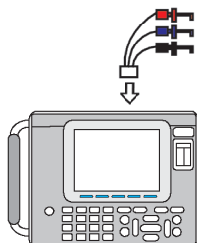

LE-8200A/LE-8200

- Probe (red) : Pick the measuring object.
(Corresponding to AI1)
- Probe (blue) : Pick the measuring object.
(Corresponding to AI2)
- Probe (black) : Pick GND of the measuring object.

-Attention-
The absolute maximum rating of the analog measurement is $\pm 25\text{V}$. Please do not use for above the rating.

4.2 Setting

1. From the top menu, press [4] to display the setting screen of the analog wave monitor function.
By pressing [F1] to switch to the digital wave monitor screen.
2. Make the analyzer calibrated if necessary.
→ 「4.6 Calibration」
3. Set the necessary settings.

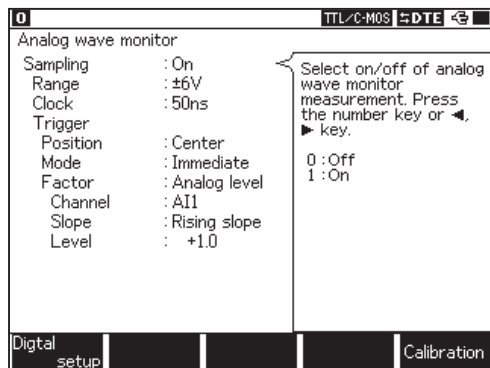

- Sampling
Select On/ Off of the analog wave monitor function
- Range
Select the measuring range of the voltage level.
- Clock
Sets the sampling clock.
(Please set the value of about 1/100 in the sampling clock which you want to measure.)

Trigger Conditions:

□Position

Set the position of trigger in the sampling memory.

Before : Capture more data which exists before the trigger condition is satisfied.

Center : Capture the same amount of data in before and after the trigger condition is satisfied.

After : Capture more data which exists after the trigger condition is satisfied.

□Mode

Immediate : Trigger can be satisfied soon after measurement starts.

Full : Trigger can be satisfied after capturing full in the sampling memory.

Select “Full” if “Position” is set to be “Before” or “Center”.

Continuous : The analyzer repeats waiting the event for trigger and displaying the data after the trigger is satisfied. This is the realtime display of Analog waveform while measuring.

□Factor

Set the trigger condition of the analog monitoring function.

If the trigger condition is satisfied, analyzer stops measuring and saves the data in the memory.

⇒ When Factor is “Analog level”

Voltage value of analog input becomes a trigger condition of the analog wave monitoring function.

□Channel

Set a channel to apply the trigger.

AI1 stands for Channel1, and AI2 stands for Channel2.

□Slope

Set a slope to apply the trigger.

Select “Rising slope” or “Folling slope” .

□Level

Select the voltage level to be the trigger condition.

⇒ When Factor is “Online”

The condition set at trigger function will be the trigger condition of the analog wave monitor function.

Bit pattern, communication error of the communication line can be a factor of trigger.

□Trigger No.

Select a trigger number.

- ▣ To learn more detail about the trigger function, read Chapter 5 or the instruction manual of analyzer.

4.3 Control of Measuring

The analyzer can display the analog waveform on its screen after the measurement, if "Immediate" or "Full" is selected on "Mode".

1. Select "on" at the analog wave monitoring function, and press [Run].
2. Press [Stop] to stop measuring.
 - If the trigger condition is not still formed in the time when [Stop] is pressed, the trigger point will not appear.
3. Press [Data] for several times to change the screen to the analog waveform.

If "Continuous" is selected on "Mode", the analog wave monitoring can be seen even while measuring.

1. Press [Run] after making the function of the analog waveform active.
2. Press [Data] for several times to change the screen to the analog waveform.
 - If the sampling clock is set to low speed like 1 ms, it may takes several seconds until the analog waveform screen appears.

4.4 Description of the Measurement Screen

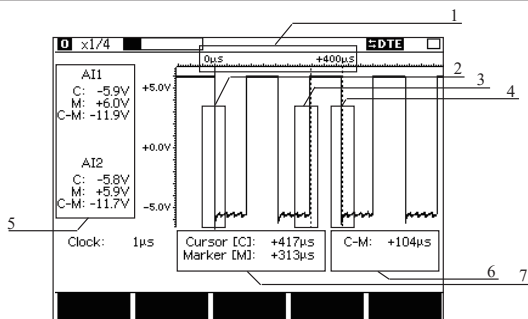

1. Elapsed time since the trigger condition is satisfied.
2. Trigger point (red line)
3. Marker point (broken line of red)
4. Cursor point (broken line of blue)
5. Cursor point, Marker point and voltage difference between two points.
6. Time between the points of cursor and marker
7. Time of cursor point and marker point.

4.5 Calibration

There is a simple calibration for the analog wave monitoring function.
It is recommended to be finished before measurement.

1. From the top menu, press [4] to display the screen of the analog wave monitor function.
Press [F1] to switch to the digital wave measurement.
2. Press [F5] to display the screen of calibration.
3. Connect the AI1 (red probe) and AI2 (blue probe) to GND (black probe).
4. Press [Run] to start calibration.
5. After the calibration, press [Menu] to go back to the top menu.

Chapter 5 Specification

Applicable Analyzer	LE-1100/LE-2100/LE-3100/LE-7000 LE-1200/LE-2200/LE-3200/LE-7200 LE-1500/LE-2500/LE-3500 LE-1500R/LE-2500R/LE-3500R LE-2500XR/LE-3500XR LE-8200/LE-8200A
Communication speed	MAX.19,200bps / MAX.38,400bps ^{*1}
Interface	Current loop (active type or passive type)
Current loop level	When acts as active side (20mA or 40mA) When acts as passive side (from 10mA to 60mA)
Protection Circuit	Built-in protection diode for reverse connection, without overcurrent protection circuit ^{*2}
Communication type	Half duplex / Full duplex
Function	Monitor / Simulation
Digital Waveform Analysis	The timing waveform analysis function of the analyzer is available. ^{*3}
Analog Waveform Analysis	The analog waveform analysis function of the analyzer is available. ^{*4}
Switch	Operation mode switching (active/passive operation) Switching of supply current during active operation (20mA/40mA)
Current loop terminal block	4-pole terminal block, 7.62mm pitch, for M3 round terminal / Y terminal
Relay cable length	0.8m
Power	supplied from the analyzer
Temperature and humidity range	In operation: 0 to 40 degree Celsius, In storage : -10 to 50 degree Celsius Humidity: 20 to 80% RH

*1 : The maximum communication speed varies depending on the version of the current loop adapter OP-1C. The maximum communication speed may be limited depending on the cable length and current value.

OP-1C	Serial	Max. Speed
Version 1	2 0 X X X X XXX	19200bps
Version 2	5 J X X X X X X	38400bps

*2 : Please be careful not to exceed 60mA when supplying the current loop current by the external power supply. If it exceeds 60mA, the internal circuit may be damaged.

*3 : LE-1100 / LE-2100 / LE-3100 / LE-7000 are not supported.

*4 : Supported by LE-8200 / LE-8200A only.

The card packed with the product is the user registration card for Japanese customers. For overseas customers, there is a registration page on our web site.(www.lineeye.com)

LINE EYE CO., LTD.

4F., Marufuku Bldg., 39-1Karahashi Nishihiragaki-cho, Minami-ku,
Kyoto, 601-8468 Japan
Phone: 81-75-693-0161 Fax: 81-75-693-0163