

## MULTI PROTOCOL ANALYZER

# *LE-2500R*

# *LE-3500R*

---

---

# INSTRUCTION MANUAL

---

---

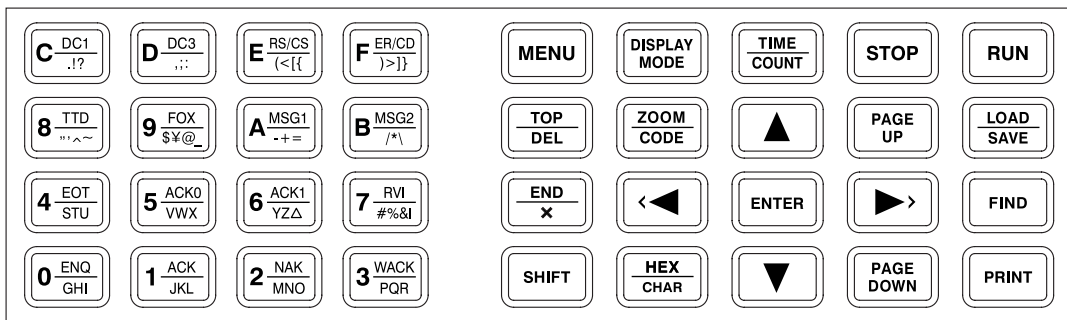



# Instruction

---

Thank you for your purchase of LE-2500R/3500R.

To use it correctly, you are advised to read and understand this instruction manual thoroughly. Keep this together with the warranty. If you encounter any problems, you will find helpful information in this manual.



## NOTICE

---

It is prohibited to reprint or duplicate any part of the whole of this instruction manual without prior permission from LINEEYE.

The content of this instruction manual and specifications of the products are subject to change without any notice.

This instruction manual has been designed and edited with great care to give you all necessary information. If you have any questions, feel free to direct your inquiries to LINEEYE.

LINEEYE makes no warranty or guarantee, either expressed or implied with respect to its quality, performance, merchantability, or fitness for a particular purpose. LINEEYE shall not be liable for direct, in-direct, special, incidental, or consequential damages resulting from any defect in the product. The warranty and remedies set forth above are exclusive and in lieu of all others.



## USER LIMITATION

---

This product has been developed for the purpose of using as an analyzer only.

When you use this product with the following devices that are required to function with a high degree of reliability, safety and accuracy, use it under considering the safe design of the system in order to maintain reliability and safety for that system;

- \*Devices that are directly related to transportation such as airplanes, trains, cars etc.

- \*Devices for crime prevention and disaster prevention.

- \*Each kind of safety devices and so on.

This product has not been developed for the use that needs exclusively high reliability and safety:

aerospace apparatus, trunk communication apparatus, nuclear control apparatus, medical apparatus related with life maintenance etc. Therefore, do not use for those purposes.

LE-2500R/3500R has Wi-Fi function (IEEE 802.11b/g/n) and emits radio wave. Please do not use near a medical device, microwave, high-level electronics, TV, radio, wireless station for mobile communications, or specified low power radio station. Where an administrator limits the use of radio devices, follow the instruction of the administrator.

Note : The Wi-Fi module used for this product conforms to SRRC(China), FCC(USA), CE(EU), TELEC(Japan),

KCC(Korea), ISED(Canada), NCC(Republic of China), however, as its product the Wi-Fi function is available only in Japan, USA, Canada, and EU nations where the product is needed to be compliant with RE directive (2014/53/EU). The Wi-Fi function of this product is set to invalid depending on the country where it is shipped. Please contact the sales department for details.

=== Notice ===

This product contains a battery.



To keep the quality of the battery, LINEEYE does not fully charge the battery.

Before using the battery, please make sure to charge the battery. When you dispose of it, please follow the regulation of the region

# Safety Information

## Read this first !!

This Safety Information includes the following important information in order to not only have you learn the right way to use the analyzer, but also prevent you from causing damage to people and property. Before using, please read the main contents after you understand the following symbols & marks.









-  **Warning** Should the device be used without following these symbols, there is a possibility of accidents, such as a death or a serious injury, occurring.
-  **Caution** Should the device be used without following these symbols, there is a possibility of accidents, such as an injury <sup>\*1</sup>, and material damage <sup>\*2</sup> occurring.
- \*1 "Injury" indicates injury, burn and electric shock, or the like which does not require hospitalization or the extended hospital visit.
- \*2 "Material damage" indicates damage related to a house, a building, furniture, apparatus, livestock or a pet.







Prohibition





The necessary

	 Warning
	<ul style="list-style-type: none"> <li>● Stop using the analyzer immediately when smoke or smells emanate from itself. Continuous use may result in an electric shock, a burn and/ or fire.</li> </ul>
	<ul style="list-style-type: none"> <li>● Stop using the analyzer when a liquid or foreign substance get into the analyzer. This may result in an electric shock or fire.</li> <li>➔ Immediately switch off the analyzer and unplug it.</li> </ul>
	<ul style="list-style-type: none"> <li>● Do not disassemble, modify or repair analyzer. This may result in a injury, an electric shock, fire, explosion and/or a breakdown due to overheating.</li> </ul>
	<ul style="list-style-type: none"> <li>● Do not put the analyzer in fire or place near the heater. This may result in a injury and fire due to overheating or explosion.</li> </ul>
	<ul style="list-style-type: none"> <li>● Stop using the analyzer should a liquid or foreign substance get into the analyzer. This may result in an electric shock or fire.</li> </ul>
	<ul style="list-style-type: none"> <li>● Never plug or unplug the AC adapter in wet hands.</li> </ul>
	<ul style="list-style-type: none"> <li>● Do not subject the analyzer to extreme conditions.</li> </ul>
	<ul style="list-style-type: none"> <li>● Do not use any AC adapter and battery other than those specified by LINEEYE. It can cause heat, fire, liquid spill, and malfunction.</li> </ul>

## ⚠ Caution

	<ul style="list-style-type: none"><li>•Do not leave the analyzer in the following conditions. Strong magnetic field, static electricity or dusty place. Temperature and humidity above the specification or where dew condensation appears. Not flat, or shaking place. Place with leaking water or electricity. Place affected by direct sun or near the fire .  Please do not leave the analyzer in the car during the summer.</li></ul>
	<ul style="list-style-type: none"><li>•Do not use at the following situations. The radio wave by the analyzer may cause trouble. Near a medical device such as cardiac pacemaker or hearing aid Near an automatic controller such as fire-alarm box or automatic door Near a microwave, high-level electronics, TV, or radio. Near a wireless station for mobile communications or a specified low power radio station</li></ul>
	<p>Remove the battery from the analyzer, when you throw away.</p>

## ⚠ Caution

	<ul style="list-style-type: none"><li>•Please follow the instruction for the AC adaptor. Do no use when it brakes. Do not damage the AC adaptor or cable. Do not place near the heater or put in the fire. Do not disassemble, modify the AC adaptor or cable. Do not curve the cable around the AC adaptor</li></ul>
	<p>Plug the AC adaptor correctly. Take off the dust from the AC adaptor. Unplug the AC adaptor when you are not using the analyzer. Unplug the AC adaptor correctly.</p>

# CONTENTS

---

---

Instruction .....	1
Safety Information.....	2
Chapter 1 Before Using the Product.....	6
1.1 Guide to This Manual.....	6
1.2 Unpacking .....	6
1.3 Major Functions and Features.....	7
1.4 Panel Information.....	8
1.5 Power Supply and Battery.....	11
Chapter 2 Basic Operation and Set-Up .....	12
2.1 Power Source ON/OFF.....	12
2.2 Set the Measurement Port (INTERFACE SETUP) .....	13
2.3 Connect to the Target Devices.....	14
Connect to RS-232C .....	14
Connect to RS-422 or RS-485.....	15
Connect to TTL interface .....	15
2.4 Characters and decimal Input .....	17
2.5 Environmental Setting (Conditions).....	18
BUFFER SELECT .....	18
RECORD&DISPLAY CONTROL(Record and Display Setting).....	19
PRINT OUT CONDITION .....	20
REMOTE CONDITION .....	20
AUTO RUN (Automatic Start and Stop).....	21
TIME & DATE SET .....	21
OTHER FUNCTION.....	21
2.6 Communication Condition Setting (Configuration) .....	22
Chapter 3 Monitor Function .....	26
3.1 Online Monitor Function (ONLINE) .....	26
3.2 Analog and Delay Time Function.....	27
3.3 Statistical Analysis Function (TREND).....	28
Chapter 4 Simulation Function.....	29
4.1 Preparation for Simulating.....	29
Registration of Transmission Data (DATA TBL).....	29
Driver Control [RS-422/485] (DRVCTRL).....	32
Terminator for RS-422/485 Port.....	32
Controlling a Control Line (LINECTRL).....	33
4.2 MANUAL Mode.....	34
4.3 Communication Reproducing Test(BUFFER).....	35
4.4 Flow Control Test(FLOW).....	36
4.5 Echo Back Test (ECHO) .....	38
4.6 Polling Test(POLLING).....	39
4.7 Program Simulation(PROGRAM) .....	42
4.8 Explanation for Each Command.....	47
Chapter 5 Bit Error Rate Test (BERT) Function .....	57
5.1 Start and End a Measurement .....	59
5.2 Data Use .....	59
Chapter 6 Useful Functions .....	60
6.1 Trigger Function (TRIGGER) .....	60
6.2 Timer/Counter Function(TM/CT).....	63
6.3 Timing Waveform Measurement Function(WAVE MON).....	64

6.4	Communication Condition Auto Setting Function(AUTO CONF)	66
6.5	Logging Function for a Long Time	67
6.6	Automatic Start and Stop Function(AUTO RUN)	68
6.7	Display Screen Switching Function	68
6.8	Translation Function	75
6.9	Retrieval Function	76
6.10	Bit Shift Function	76
6.11	Recording Function to Measure Additional Information ( Idle Time, Time Stamp etc. )	76
	Idle Time Display Function	76
	Time Stamp Function	77
	Line State Display Function	77
<b>Chapter 7</b>	<b>Data Usage</b>	<b>79</b>
7.1	Hard Copy Printing	80
7.2	Normal Printing	80
<b>Chapter 8</b>	<b>Save and Load Data</b>	<b>85</b>
8.1	Storage Device	85
8.2	File Management Function	85
<b>Chapter 9</b>	<b>Documents</b>	<b>88</b>
9.1	Calculation of Block Check	88
9.2	Communication Clock	89
9.3	Frame	90
9.4	Data Code Table	91
9.5	Specifications of Translation Display	95
	BSC Translation Display	95
	Frame Level Translation Display	95
	Packet Level Translation Display	98
	PPP Translation Display	100
<b>Chapter 10</b>	<b>Specifications and Maintenance</b>	<b>103</b>
10.1	Specifications of Function and Hardware	103
10.2	Ports	105
	RS-422/485 Port	105
	TTL Port	105
	RS-232C (V.24) Port	106
	External Input/Output Terminal	106
	AUX(RS-232C) Port	107
	USB Device Port	107
	USB Host Port	107
	USB Driver Installation	108
10.3	Soft Reset	109
10.4	Using the Latest Function	109
10.5	Troubleshooting	110
10.6	Warranty and After service	111
	Warranty	111
	User Registration	111
	Repair	111
	After Support	111

# Chapter 1 Before Using the Product

## 1.1 Guide to This Manual

---

Descriptions in this manual assume the following:

### Functions of Each Model

---

- This manual describes the following models: LE-3500R and LE-2500R. To learn about functions of each model, read the Chapter 10 “Specifications of Function and Hardware.”

### Screen Display Representation

---

- Printed representation of screen displays in this manual may not be the same as that actually displayed concerning the font and special symbols.
- Descriptions of parts of the screen being displayed are enclosed in double quotation marks “.”
- Flashing of the cursor or the like is not represented in this manual.

### Representation of the Operating Procedure

---

- Represent keys in [ ]  
eg. Press  key. →Press [MENU].
- Successive key operations may be represented by putting their symbols one after another.  
eg. Press [MENU], then press [0] to make a selection →Press [MENU],[0]to make a selection.
- Pressing two keys at the same time is represented by combining their symbols with “+.”  
e.g. Press [SHIFT] and [PRINT] at the same time →Press [SHIFT]+[PRINT] to make a selection.

## 1.2 Unpacking

---

### When you unpack the product, make sure of the following:

---

- The product has not been damaged during transit.
- You have received all the standard accessories listed below.
  - Protocol Analyzer 1
  - Interface Sub-board ( attached to the analyzer ) 1
  - Wide input AC Adapter ( Model : 6A-181WP09 ) 1
  - DSUB25pin Monitor cable ( Model : LE-25M1 ) 1
  - DSUB9pin branch cable ( Model : LE-009M2 ) 1
  - DSUB25-9 conversion adapter 1
  - 5-wire TTL probe ( Model : LE-5LS ) 1
  - USB Cable 1
  - Utility CD 1
  - Carrying bag ( Model : LEB-01 ) 1
  - Instruction Manual ( This book ) 1
  - Registration card, Warranty 1
-  The card packed with the product is the user registration card for Japanese customers. For overseas customers, there is a user registration page on our web site.( <https://www.lineeye.com> )

Please let us know if you find any damage to the product caused by transportation, or if there are accessories lacking.

- Utility CD

This CD contains the following:

- Manual folder : Instruction manuals for analyzer and options.
- Utility folder : PC link software (light edition), Utility software, and a software to transfer the firmware
- Driver folder : USB driver for analyzer to connect with PC.



## 1.3 Major Functions and Features

---

LE Series are handheld communication protocol analyzers. They are powerful tools for the development and inspection of communication systems devices, and for the diagnosis of communication networks.

### Functions

---

This product comes standard with two interfaces for both RS-232C (V.24), RS-422/485, and TTL. It can be connected to various types of transmission lines by using optional interface sub-boards. It is capable of handling any communication system from synchronous transmission to real communication networks working on BSC, SDLC, X.25 and other protocols.

◆ **On-line Monitoring**

Monitors communication protocol or the transmission data on-line to check for existence of hindrance in the line or to analyze the communication.

◆ **Simulating**

Executes operating transmission of data as communication partner for tested devices/equipment.

◆ **Bit Error Rate Test**

Evaluates the quality of the data communication channel, including modems.

### Features

---

- High-Speed Communication (Max. 2.048Mbps : LE-3500R, Max. 1Mbps : LE-2500R)
- Various monitor/analysis capabilities to multi-protocols
- Program simulation as a standard function [LE-3500R]
- Expandability to communicate through various interfaces (TTL, I<sup>2</sup>C, SPI, IrDA, CAN, LIN, current loop)
- AUTO SAVE function which can record measured data into SD card or USB flash memory for a long time.
- Useful timing waveform measurement function at the time of timing trouble regarding bit unit
- Battery-powered for 6.5 to 8 hours, light-weight (Approx. 800g), and compact design for field application
- Remote control by Wi-Fi (The Wi-Fi function is available only in Japan, USA, Canada, and EU nations where the product is needed to be compliant with RE directive (2014/53/EU).)

### Optional Accessories

---

■ **Interface Sub-Board B**

By exchanging an interface sub-board for another, various protocols can be corresponded to and measured.

- OP-SB5GL Expansion kit for TTL/I<sup>2</sup>C/SPI
- OP-SB10N Expansion kit for RS-232C/RS-530 (RS-422/RS-485)
- OP-SB7GX Expansion kit for CAN/LIN
- OP-SB1C Expansion kit for current loop

■ **Cable**

- LE-25Y15 Monitor cable for X.21
- LE-25Y37 Monitor cable for RS-449
- LE-25M34 Monitor cable for V.35

■ **SDHC Card**

It can be used for saving measured data and set-up conditions and for continuously recording for a long time.

- SD-32GX 32GB SD card [LE-3500R]
- SD-16GX 16GB SD card
- SD-8GX 8GB SD card

■ **Compact Thermal Printer**

- DPU-414-PA Handy thermal printer for on-site printout of measurements

■ **Software**

The Windows software enables the analyzer to cooperate with a PC on measuring.

- LE-PC300R PC link software(for Windows)
- LE-PC7GX PC link software for measuring CAN and LIN communication(for Windows) Ver.2.0 or later.  
(This software needs OP-SB7GX,CAN/LIN Communications Expansion Kit.)

■ **Firmware**

- OP-FW10R High-speed HDLC/SPI firmware[LE-3500R]

## 1.4 Panel Information

### General

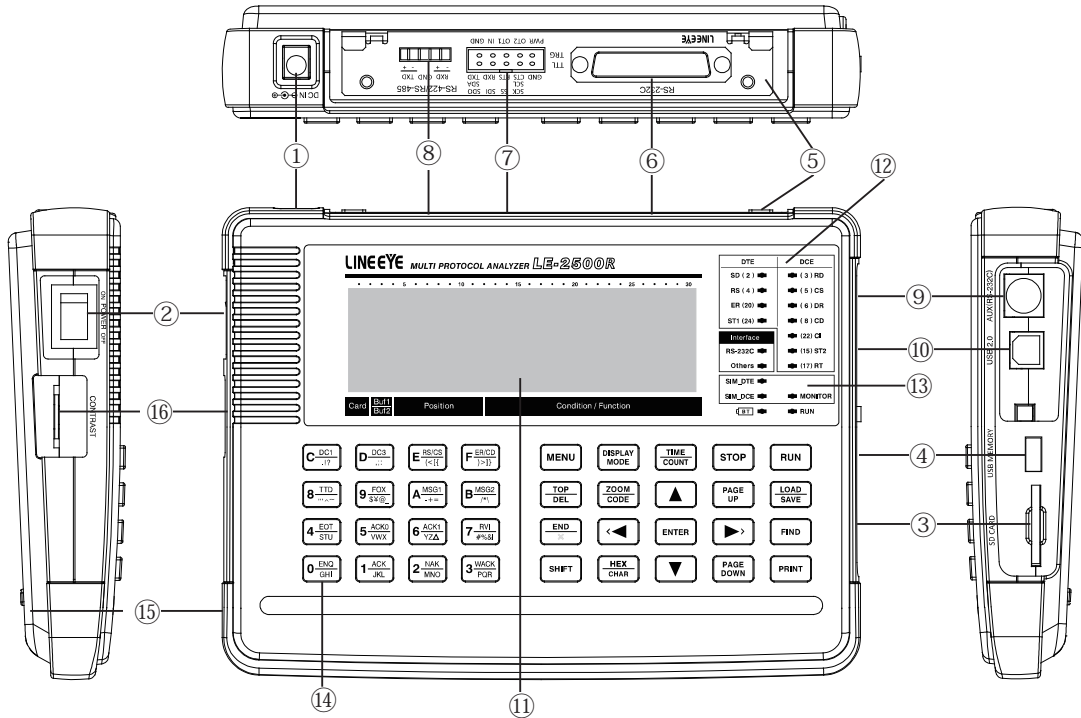

Name		Function
①	AC Adapter Plug	Connects the AC adapter.(It deals with the polarity of plus and negative.)
②	Power Switch	Turns the power on/off.
③	SD Card Slot	The inlet for a SD card
④	USB Host Port	To connect to a USB flash memory
⑤	Interface Sub-Board	A sub-board equipped with RS-232C, RS-422/485, and TTL interface
⑥	RS-232C Port	Measurement port for RS-232C (V.24)
⑦	TTL/ External Signal I/O terminal	Measurement port for TTL. A port for external signal I/O
⑧	RS-422/485 Port	Measurement port for RS-422/485
⑨	AUX(RS-232C) Port	Used to input or output external equipment equipped with RS-232C interface.
⑩	USB Device Port	Uses for a remote-control from a PC, or for updating firmware.
⑪	Liquid Crystal Display	Wide view angle and high contrast liquid crystal display.
⑫	Line State LED	Indicates logical status of signal line on the target interface.
⑬	Action State LED	Indicates the status of an analyzer's operation.
⑭	Keypad	Press to enter commands and data.
⑮	Battery Cover	Open only when replacing the nickel-hydrogen battery.
⑯	Contrast Adjust Knob	Adjusts the display contrast.

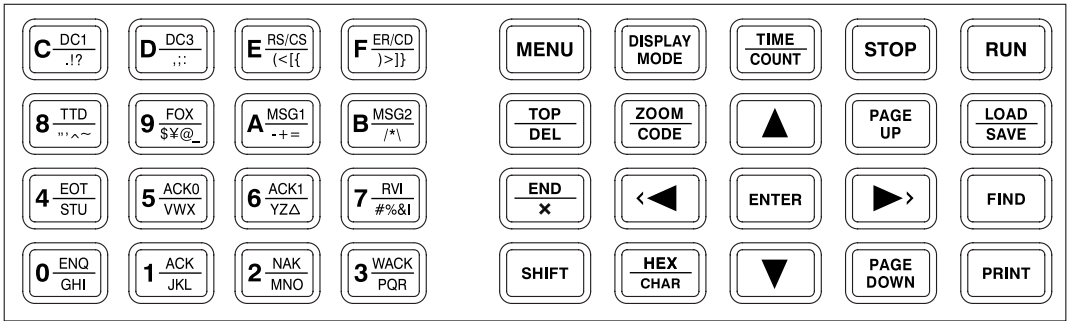

Key	Function
[ RUN ]	Starts monitoring, measuring or testing operation.
[ STOP ]	Stops monitoring, measuring or testing operation. Interrupts printing.
[ MENU ]	Returns to the top menu for selecting functions and setting conditions. *Returns to the previous screen.
[ DISPLAY MODE ]	Displays the monitored or measured data. Switches over to the display format.
[ TIME/COUNT ]	Switches to counter/timer display and timing waveform display.
[ LOAD/SAVE ]	Sets configuration of file management for the storage device.
[ FIND ]	Switches over to the retrieval function.
[ PRINT ]	Switches over to the printing function.
[ HEX/CHAR ]	Switches over the monitored data displayed in char. to one in hexadecimal.
[ ZOOM/CODE ]	Zooms up in the timing waveform screen. Changes the display code of monitored data.
[ PAGE UP ]	Goes to previous data. Moves the setting items upward.
[ PAGE DOWN ]	Goes to next data. Moves the setting items downward.
[ ▲ ], [ ▼ ]	Scrolls the data line. Moves the cursor on the condition setting screen.
[ ◀ ], [ ▶ ]	Scrolls the displayed data character by character. Changes or selects the setting item on the condition setting screen.
[ ENTER ]	Definite input for execution of function or a command. Pauses the display when pressing the key during the measurement.
[ 0 ]~[ F ]	Enters the corresponding numerical values. Selects an item number or the data to be sent.
[ TOP/DEL ]	Displays the top section of data. Deletes the entry indicated by the cursor.
[ END/X ]	Jumps to the end of the screen. Enters data "Don't Care."
[ SHIFT ]	Press to use the expanded alternate function of each key.
[ SHIFT ] + [ PRINT ]	Prints a hard copy (screen image).
[ SHIFT ] + [ FIND ]	Sets configuration of retrieval condition.
[ SHIFT ] + [ PAGE UP ]	Moves to the setting help screen upward.
[ SHIFT ] + [ PAGE DOWN ]	Moves to the setting help screen downward.
[ SHIFT ] + [ 0 ]~[ D ]	Selects the fixed transmission data.
[ SHIFT ] + [ E ], ([ F ])	Turns the control line RS[CS](ER [CD]) on/off.
[ SHIFT ] + [ ▲ ], [ ▼ ]	Switches BUF 1 or BUF 2 when a buffer memory is divided into two parts. Switches signals on the timing observation screen.
[ SHIFT ] + [ ◀ ], [ ▶ ]	Displays the monitored data in bit shift. Moves a cursor on the timing observation screen.
[ SHIFT ] + [ ZOOM/CODE ]	Zooms down on the timing observation screen. Change the code in the opposite order of "CODE".
[ SHIFT ] + [ DISPLAY MODE ]	Turns on/off the back light of LCD.
[ SHIFT ] + [ HEX/CHAR ]	Switches a character input mode.
[ ENTER ] + [ TOP/DEL ]	Initializes to the factory setting by pressing it at the time of turning on the power.
[ 1 ] + [ D ]	Starts the diagnostics test if pressing these keys when turning on the power.

■ LCD Display

The LCD displays the measurement conditions, the monitored data and the measured results.

The following information is displayed on the bottom line on the opening screen and the monitor data screen, corresponding to the caption printed below the LCD.

Printed Caption	Display	Meaning of Caption
Card	<Space>	A memory card is not inserted.
		A memory card is inserted.
		Unacceptable memory card is inserted.
Buf1/Buf2		A buffer memory is not divided.
		A buffer memory is divided into two parts, with the former half (BUF1) is in use.
		A buffer memory is divided into two parts, with the latter half (BUF2) is in use.
Position	Number	Displays data position on the upper left of the display screen.
Condition/ Function	Message	Displays the transmission speed and display code. Displays the call status of each function.

■ Line State Indicator LEDs

These LEDs indicate the logical status (voltage level) of the INPUT/OUTPUT data on the signal lines connected to the measurement port in real time. There are two groups: DTE drive signal and DCE drive signal.

- A signal name and pin number correspond to the RS-232C port.
- The correspondences between signals and LEDs are shown in the following table:

Voltage Level on the Signal Lines			Two-Color LED	
RS-232C	RS-422/485	TTL	Red	Green
+3V≤VM	VA-VB>+0.2V	VT<VIL	Light on	Light off
-3V<VM<+3V	VA-VB<+0.05V	VIH<VT	Light off	Light off
VM<-3V			Light off	Light on

VM : Voltage Level of RS-232C

VT: TTL Level

VA : Voltage Level on the RS-422/RS-485 [-Terminal] VIH: Minimum of the threshold of input level H

VB : Voltage Level on the RS-422/RS-485 [+Terminal] VIL: Maximum of the threshold of input level L

DTE	DCE
SD ( 2 )	( 3 ) RD
RS ( 4 )	( 5 ) CS
ER (20)	( 6 ) DR
ST1 (24)	( 8 ) CD
	(22) CI
	(15) ST2
	(17) RT

■ Action State Indicator LEDs

These LEDs indicate the operating status by turning on/off a light of the analyzers.

LED	Status
RS-232C	RS-232C port is available.
Others	Ports but RS-232C (e.g. RS-422/485) are available.
SIM_DTE	Analyzers serve as DTE. The simulation and the bit error test functions are available.
SIM_DCE	Analyzers serve as DCE. The simulation and the bit error test functions are available.
MONITOR	The monitor functions are available.
RUN	The monitor, the measurement or the test function is running.
BT	<ul style="list-style-type: none"> <li>• Red lighting : Battery Warning (Batteries are almost dead.)</li> <li>• Green blink : Recharging batteries</li> <li>• Green lighting : The charge is completed</li> <li>• Green high-speed blink : The charge is error (indicates the battery deterioration and disconnection)</li> </ul>

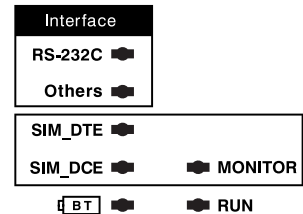

## 1.5 Power Supply and Battery

This analyzer can perform AC power operation by attached AC adapter and battery drive by built-in rechargeable battery. The measurement setting is backed up by the battery even if the power supply is OFF. (However measured data will be erased when power supply is OFF.)

### Attached AC Adapter

Wide range input AC adapter is attached.

- Input : 90V AC to 264V AC (Rating 100V AC to 240V AC), 50/60Hz
- Output : 9V DC±5%, 2.0A max, Center positive
- Safety :PSE, UL, CUL, CCC, CE

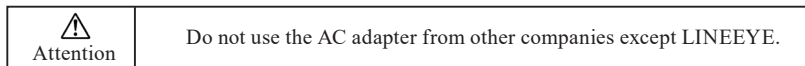

### Recharging the Battery

The Nickel-Hydrogen battery is built in and can perform the battery drive of about 6.5 to 8 hours when fully charge.

1. Plug the attached AC adapter into an AC power outlet.
2. The battery is recharged by connecting the plug of AC adapter into the AC adapter jack of analyzers, and BT LED will blink in green slowly.
3. The charge is completed when BT LED lights in green.

- ▢ The battery will be fully recharged in about 2.5 hours when the power switch is OFF. When the power switch is ON, the time for the charge will be a bit longer.
- ▢ BT LED will light in red when the battery is running short.
- ▢ When the LED repeats high-speed blink, indicates that the charge cannot be performed. It might be the battery deterioration and disconnection. Exchange to the new battery.
- ▢ Please recharge when the temperature is within the range of 5 °C to 40 °C. The charge is not started at any temperature other than this range.
- ▢ Be sure to use the AC adapter provided with this analyzer.

### Replacement of Battery

#### ■ Nickel-Hydrogen Battery

In a usual state of use, about 300 times charge and electric discharge use is possible, but if the battery can no longer drive your analyzer, or the service time after charging becomes extremely short, the battery must be replaced with a new one. (When you replace the batteries, turn OFF the power.)

1. Remove the battery cover from the bottom of your analyzer.  
Disconnect the connector of the lead line on the battery and remove the battery.
2. Connect a new battery to the connector and set it in the battery holder. Put back the battery cover and tighten screws with great care so that the lead line is not pinched.

- If you are not going to use the analyzer for a long term, fill up the battery before finishing it.  
After that, try to charge the battery every 6 month.
- A replacement Nickel-Hydrogen battery is to be ordered from the dealer who supplied your analyzer.
- New orders for batteries have to be paid even if it is still during warranty period because batteries are considered consumable parts.

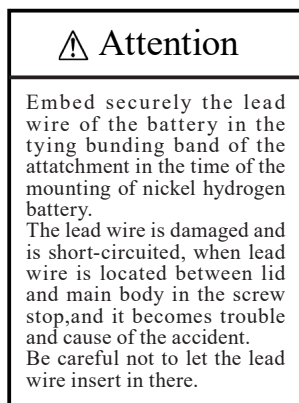

Install the base of the lead wire in the direction on the level.

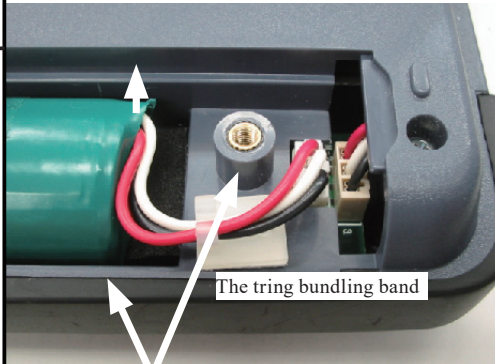

The position with the danger which holds the lead wire

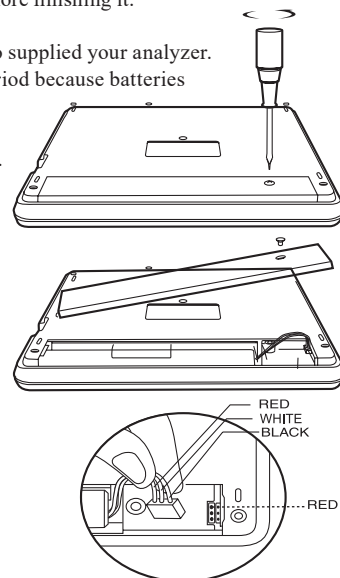

#### ■ Lithium Battery

The data of memory IC and timer IC is backed up for about 5 years by built-in Lithium battery even if the power supply is OFF. Every time the message “INITIALIZED!” is displayed on the opening screen of after turning on the power, it is time to replace the lithium battery.

- ▢ Exchanging Lithium batteries is done as exchange work in the factory.

# Chapter 2 Basic Operation and Set-Up

## 2.1 Power Source ON/OFF

### Power Source ON

Turn on the power of analyzer (Press left side button.)  
The opening screen will be displayed after the self-check test.

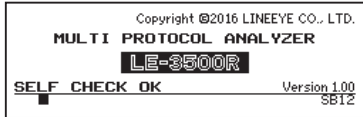

- If "SELF CHECK NG" is displayed in the opening screen, please contact LINEEYE distributors or LINEEYE directly.
  - If <Firmware loader> is displayed, insert the appropriate sub-board and load the firmware to the analyzer.
- 10.4 Use the Latest Functions
- Use the AC adapter if BT LED lights on red.

#### Adjustment of the LCD display

If the contrast of the screen is too deep or too light, adjust it with the contrast adjust knob located on the right side of your analyzer.

- When no display is shown on the screen, it can be due to excessively light contrast. Try adjusting the contrast knob.

#### ON/OFF of Backlight

Press [SHIFT] + [DISPLAY MODE] to turn on/off the backlight.

- Using the backlight makes battery drive time shorter than when it is not used.

2.5 Environmental Setting (Conditions)

### Selecting the Functions

Press [MENU] to display the top menu screen.



The "◀" mark tells you what function is selected.

Press [▲], [▼], [◀], or [▶] to move "◀" mark and select the function.

- The top menu screen will not be displayed while measuring (RUN LED is blinking).

### Setting Change

"SETUP" menu is displayed on the right side of the top menu.

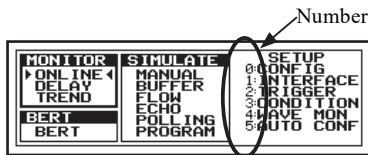

When you want to change the setting, press a SETUP number ( [0] to [F] ) on the top menu screen to display the setting screen. Depending on what you select (MONITOR etc), the setting screen may be different. For example "2:TRIGGER", "3:CONDITION" etc. are displayed in the left picture.

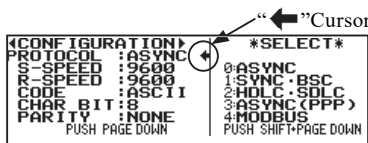

Move the cursor ("▶") by [▼], [▲], [PAGE DOWN], [PAGE UP] and select the setting ("SELECT") shown on the right side of the screen by pressing [◀], [▶] or [0] ~ [F] keys.

- When the selected items of "SELECT" have more than one page to display, press [SHIFT]+[PAGE DOWN]/[SHIFT]+[PAGE UP] to go to the previous/next page.

2.5 Environmental Setting (Conditions)

2.6 Communication Condition Setting (Configuration)

### Connection to the Target Devices

Select the appropriate measurement port and connect the target device to the analyzer.

2.2 Set the Measurement Port (INTERFACE SETUP)

2.3 Connect to the Target Devices

## Start and Stop Measurement

When [RUN] is pressed, RUN LED starts lightening and the selected measurement function begins. During the measurement, the analyzer saves data to the memory displaying the data on the screen in real time.

When [Stop] is pressed, RUN LED stops lightening and displays the last data measured. It is possible that measurement stops automatically under the specific conditions by the trigger function.

- When the capture buffer protection, automatic start/ stop function and logging function for a long time are set, the messages like "WRITE PROTECT," "AUTO RUN WAIT" and "AUTO SAVE FILE EXIST" will be displayed.

 2.5 Environmental Setting

 6.1 Trigger Function

 6.5 Logging Function for a Long Time

 6.6 Automatic Start and Stop Function

## Use of Measured Data

Measured data can be displayed by scrolling the screen. (press [▲], [▼], [◀], [▶], [PAGE DOWN], [PAGE UP])

There are some useful functions such as search function to find the specific data, print-out function to output data displayed on the screen, and file management function to save the measured data/ setting conditions in the memory card.

 Chapter 6 Useful Functions

 Chapter 7 Data Usage

 Chapter 8 Save and Load Data

## Power Source OFF

Turn off the power switch. (Press the left side switch.)

The measurement conditions, which have been set, is saved even after the power is turned off.

- In the case of turning off the power during measuring, the data will not be saved. To save in the memory card, make sure you stop measurement and turn off the power.

## 2.2 Set the Measurement Port (INTERFACE SETUP)

Select the measurement port which is used in the target device.

Press [1] on the top menu screen([MENU]), and select "INTERFACE."

← INTERFACE →	*SELECT*
PORT : RS232C ←	0:RS232C
MODE : DTE	1:RS485
POLARITY : NORMAL	2:TTL
LINCTRL : OFF	

← INTERFACE →	*SELECT*
PORT : RS485 ←	0:RS232C
MODE : DTE	1:RS485
POLARITY : NORMAL	2:TTL
DRVCTRL : OFF	

← INTERFACE →	*SELECT*
PORT : TTL ←	0:RS232C
LEVEL : 5.0V	1:RS485
OUTPUT : PUP	2:TTL
POLARITY : NORMAL	
CLK POLA : NORMAL	

- When an available port is selected, setting items varies depending on what expansion board is put on your analyzer.

### ■ PORT (Selecting Ports to Measure)

Select "RS232C" to measure RS-232C, "RS485" to measure RS-422/485, "TTL" to measure TTL interface.

- The action LED light of RS-232C and Others will be switched.

### ■ MODE (DTE/DCE Switch)

Select the specification of signal input/output for the measurement port while using Simulation or BERT function. Select "DCE" if the target device is "DTE". Select "DTE" if the target device is "DCE".

 10.2 Ports

- "DTE" is widely used in PC and data terminal devices. "DCE" is widely used in modems and terminal adapters etc.
- LED lighting for SIM DTE and SIM DCE is switched when using the Simulation or BERT function.
- When monitoring is executed, setting this is not necessary.
- Only during[RUN], signal of measurement port will be the output pin when using Simulation or BERT function.

### ■ POLARITY (Polarity Switch)

Normally select "NORMAL".

- In INVERT, all the signal polarity of SD and RD including the idle state of the line is inverted.

### ■ DRVCTRL (RS-485 driver control)

Setting of the driver IC control method when selecting "RS-485"

### ■ LINCTRL (Control of the control line)

Control setting of the control line when selecting "RS-232C"

■ V.35 MODE (V.35 Setting) [OP-SB10N]

Normally select "OFF". Select "ON" only when use with OP-SB10N.

■ LEVEL (signal voltage level selection)

Selection of the signal voltage level of the measurement target when selecting "TTL". Select from 5.0V, 3.3V, 2.5V, or 1.8V depending on the specification of the target hardware.

■ OUTPUT (Output selection)

Output selection of the simulation when "TTL" is selected. Select from "PUP" (open collector output with pull-up resistor), "NO-PUP" (open collector output without pull-up resistor), or "CMOS" (CMOS push pull output) depending on the hardware specification of the target device.

■ CLK POLA (polarity setting of clock signal)

Selection of the polarity of the clock signal

☞ When selecting "INVERT", only the polarity of the clock signal will be inverted.

☞ For the measurement of V.35, expansion board (OP-SB10N) and the dedicated cable (LE-25M34) are needed.

## 2.3 Connect to the Target Devices

### Interface Port

The analyzer has RS-232C, RS-422/RS-485, and TTL ports.

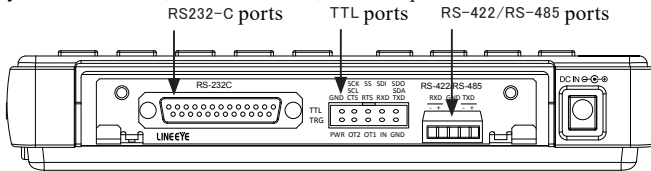

### Connect to RS-232C

To measure RS-232C(V.24), select "PORT" to "RS232C" at "INTERFACE".

☞ 2.2 Set the Measurement Port (INTERFACE SETUP)

■ On monitoring the transmission data

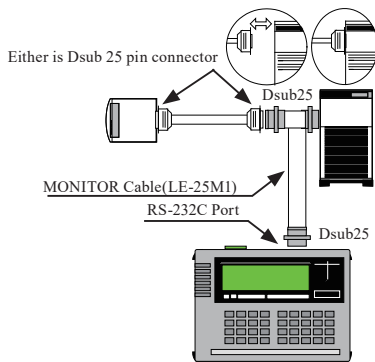

Connect the monitor cable (LE-25M1) and Dsub 25pin connector of RS-232C cable on the target device.

[ Connection of LE-25M1 ] ( ) is the pin number.

Dsub25pin male	Dsub25pin male	Dsub25pin female
(1) -----	(1) -----	(1)
(2) -----	(2) -----	(2)
(3) -----	(3) -----	(3)
(4) -----	(4) -----	(4)
.	.	.
.	.	(connected to the same numerical pin)
.	.	.
(24) -----	(24) -----	(24)
(25) -----	(25) -----	(25)

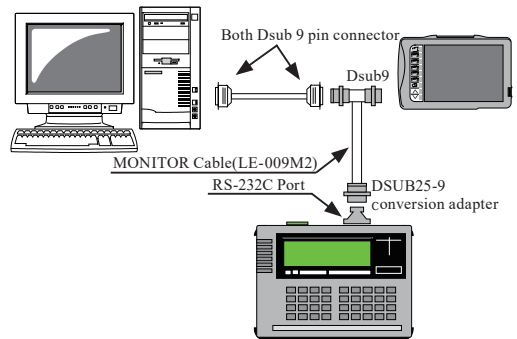

Use the DSUB25-9 conversion adapter and DSUB 9pin branch cable (LE-009M2) to connect to RS-232C cable.

[ Connection of LE-009M2 and DSUB25-9 adapter ] ( ) is the pin number.

DSUB25-9 adapter	LE-009M2
Dsub25pin male	Dsub9pin male female Dsub9pin female Dsub9pin male
(8) -----	(1) ----- (1) ----- (1)
(3) -----	(2) ----- (2) ----- (2)
(2) -----	(3) ----- (3) ----- (3)
(20) -----	(4) ----- (4) ----- (4)
(7) -----	(5) ----- (5) ----- (5)
(6) -----	(6) ----- (6) ----- (6)
(4) -----	(7) ----- (7) ----- (7)
(5) -----	(8) ----- (8) ----- (8)
(22) -----	(9) ----- (9) ----- (9)



■ Transmit/ Receive the test data. (Simulation)

Connect the analyzer and the target device.  
Connect as following, concerning the specification of target device (DTE/DCE) and the RS-232C cable.

- DTE device -----Straight cable -----Analyzer (DCE setting)
- DCE device -----Straight cable -----Analyzer (DTEsetting)
- DTE device ----- Cross cable -----Analyzer (DTEsetting)
- DCE device ----- Cross cable -----Analyzer (DCEsetting)

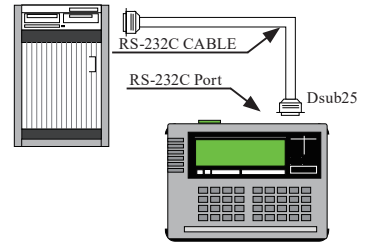

Connect to RS-422 or RS-485

To measure RS-422/485, set "PORT" to "RS" at "INTERFACE".

When the RS-422/485 of the target device is connected by a connector or terminal of unique specification, confirm the pin arrangement and make a balanced transmission pair cables to connect the device to the RS-422/RS-485 terminal of the analyzer. The terminal of the analyzer is detachable, thus detach it and connect the cable and then attach it to the analyzer.

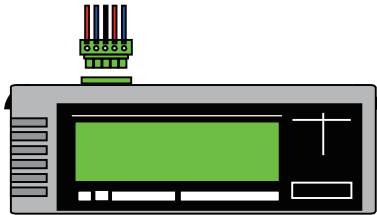

■ Monitoring the RS-422 line between Device A and Device B

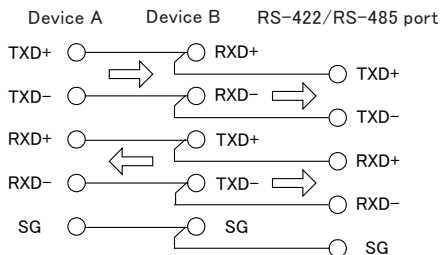

Transmission data of device A is measured in SD and reception data of device B is measured in RD..

2.2 Set the Measurement Port(INTERFACE SETUP)

10.2 Ports

2.2 Set the Measurement Port (INTERFACE SETUP)

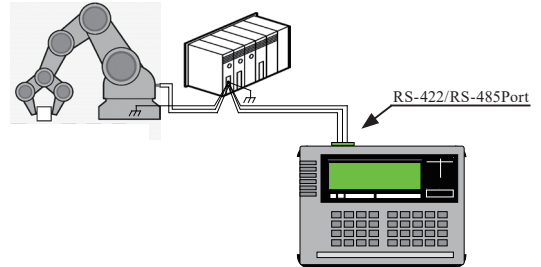

Connect the SG (signal ground) of the target device to the SG of the analyzer.

■ Simulating the transmission to the device of RS-422 port.

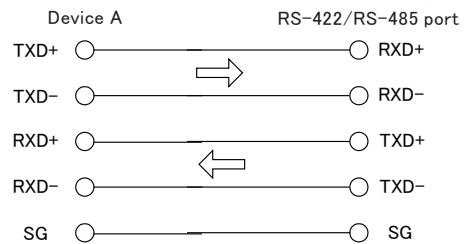

Set RS-422/RS-485 port to DTE mode.  
 Set "On" to the terminal control of RXD of RS-422-RS-485 port.

■ Monitoring or Simulating the transmission to the device of RS-485.

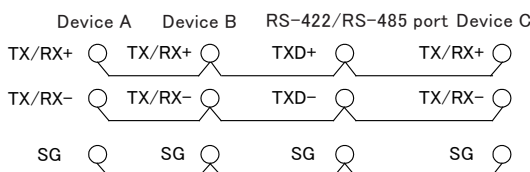

When measuring RS-485 half duplex, connect the analyzer as one of RS-485 nodes.  
 When it is in simulation mode and the cable connection is like the left figure, set it to DTE mode  
 When connecting the analyzer as terminal (if you do not have Device C in the left picture.) set "On" to the terminal control of TXD of RS422/RS-485 port.  
 Transmission/ reception data on RS-485 is measured in SD.

When using for RS-485, The analyzer cannot distinguish data from device A and data from device B. Both data will shown on the SD line (when it is connected like above). In this situation, by adding timestamp, communication data visualization will improve.

2.5 Environmental Setting (Conditions)

When you measure UART of TTL, I2C, or SPI set the “PORT” item of “INTERFACE” setting to “TTL” and connect the analyzer with the target by dedicated cable.

■When you execute monitoring or send/receive simulation of TTL level line

Lead wire	Signal name	Definition
Brown	TXD/SDA/SDO	Monitor input / Simulation output of SD data. SDA input/output of I2C. SDO input/output of SPI.
Red	RXD/SDI	Monitor input of RD data. SDI data input of SPI.
Orange	RTS/SS	Monitor input / Simulation output of RTS control line.
Yellow	CTS/SCL/SCK	Monitor input of CTS control line. SCL input/output of I2C. SCK input/ output of SPI.
Green	GND	Signal Ground

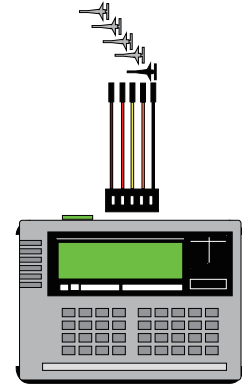

< Connection example of UART monitoring >

Signal	Lead wire	Input/Output		Signal of target device	
		Monitor	Simulation	Monitor	Simulation
TXD	Brown	I	O	TXD	RXD
RXD	Red	I	I	RXD	TXD
RTS	Orange	I	O	RTS	CTS
CTS	Yellow	I	I	CTS	RTS
GND	Green	-	-	Signal GND	Signal GND

“I” is an input to the analyzer. “O” is an output from the analyzer.

< Connection example of I2C monitoring >

Signal	Lead wire	Input/Output		Signal of target device	
		Monitor	Simulation	Monitor	Simulation
SDA	Brown	I	I/O	SDA	SDA
SCL	Yellow	I	I/O	SCL	SCL
GND	Green	-	-	Signal GND	Signal GND

“I” is an input to the analyzer. “O” is an output from the analyzer.

< Connection example of SPI monitoring >

Signal	Lead wire	Input/Output		Signal of target device		
		Monitor	Simulation	Monitor	Simulation	
					Master mode	Slave mode
SDO	Brown	I	O	MOSI	MOSI	MISO
SDI	Red	I	I	MISO	MISO	MOSI
SS	Orange	I	I/O	SS	SS	
SCK	Yellow	I	I/O	SCK	SCK	
GND	Green	-	-	Signal GND	Signal GND	

“I” is an input to the analyzer. “O” is an output from the analyzer

When it is in master simulation output of SS and SCK will be (O), and when it is in slave the input will be (I).

## 2.4 Characters Input

Move the cursor “■” to a space to input data using [◀],[▶].

The input space is the place which the cursor “■” is blinking at. When you input data in the middle of existing data, the characters are inserted.

As inputting is continued, the cursor is automatically moved to next space. When you edit/correct the inputted data, move to the place to be corrected using [◀],[▶]. Then, input again. To delete data, move the cursor to the beginning of data to be deleted, and press [TOP/DEL].

Inputting method (HEX or characters) is shown in the screen of analyzer.

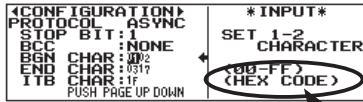

HEX Input only

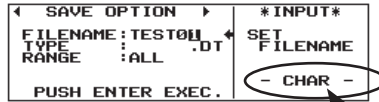

Character Input only

When inputting the transmission data for simulation, you can use both HEX input and character input in the same sentence.

### ◆ HEX Input

When data is inputted in a hexadecimal format, it is converted to a character in the data code set by configuration at the same time of input.

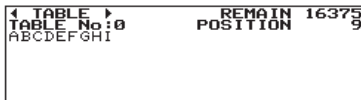

eg. ASCII

Key Input [4][1]  
Data Display 04 → 41 → A

When you want to display inputted data in a hexadecimal format, press [HEX/CHAR].

### ◆ Character Input

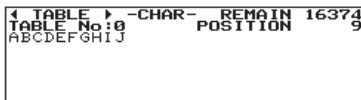

When inputting data with a character, press [SHIFT]+[HEX/CHAR].

In this case, “- CHAR -” is displayed at the center of the upper part on the screen.

When you use character input, the following can be used for input; letters printed on each key and letters printed below each key.

eg.[0]

“0” → “G” → “H” → “ I ” → “g” → “h” → “ i ”

To display inputted data in a hexadecimal format, press [HEX/CHAR].

Press [SHIFT]+[HEX/CHAR] to go back to character input.

### ◆ Binary Input

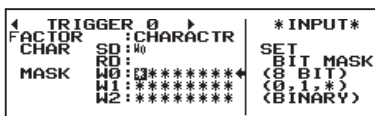

When binary is inputted, use [0],[1],[END/X], and input every one bit where the blinking mark is displayed.

## 2.5 Environmental Setting (Conditions)

- The condition menu allows the setting of the environmental conditions required to operate your analyzer.



To select “CONDITION,” press [3]“CONDITION”on the top menu screen ([MENU]).

- On the condition menu, the following operating conditions can be set:

Item	Setting Conditions
0 BUFFER SELECT	Sets the allocation of partitions in the capture buffer to store the measured data. Selects ON/OFF for the protection of the capture buffer, buffer full stop function, automatic back up function, AUTO SAVE function, and automatic saving file. Selection of save device.
1 RECORD & DISPLAY CONTROL	Selects and sets ON/OFF for each display; idle time, time stamp, line status. Selects BSC translation
2 PRINT OUT CONDITION	Sets printing conditions and selects an output port.
3 AUX CONDITION	Sets the AUX communication conditions. Wi-Fi setting
4 AUTO RUN	Sets ON/OFF of the automatic start/ stop. Sets the starting/ending time and ON/OFF of the automatic RUN.
5 TIME & DATE SET	Sets time and date (Sets the built-in clock).
6 OTHER FUNCTION	ON/OFF of the key click sound, time until automatically turning OFF the backlight, ON/OFF of the [RUN] operation check display, ON/OFF of prohibition of measurement at the time of battery warning, ON/OFF of prohibition of simulation.

- Press a number key corresponding to each menu number to go to each setting screen or move the mark “→” to the menu number using [▲],[▼], . And then, press [ENTER].

### BUFFER SELECT

Sets the capture buffer for saving the measured data.

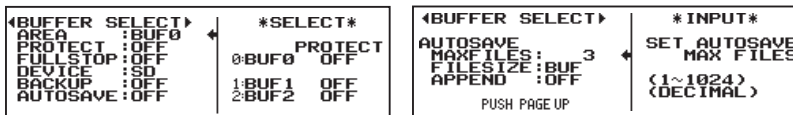

- AREA(Buffer Partition)

Whether a memory is used as one capture buffer or two capture buffers can be selected.

BUF0 can be used as one capture buffer.

When BUF1 and BUF2 are selected, the capture buffer is divided into two and then they are measured separately.

- PROTECT(Buffer Protection)

This is function to prevent the data stored in the buffer memory from being inadvertently overwritten.

- OFF: Allow to overwrite data in the capture buffer. When you load the data from a memory card, captured data will not be saved and loaded data will take over the place.

- ON: Prevent the data stored in the buffer memory from being inadvertently overwritten.

The write-protect can be set for each capture buffer partition.

- FULLSTOP(Ring Buffer Setting)

This function selects the operation when the capture buffer is full.

- OFF: Data will be overwritten from the beginning of capture buffer. In short, old data will be deleted.

- ON: The operation will stop as soon as a memory capacity, in capture buffer partition set on “AREA” function, is full.

 Every reception/ transmission, timestamp/ idle time, line states consumes 4 bytes.

- DEVICE (selection of save file direction)

Select from SD card or USB flash for the saving direction of auto save or trigger save.

- SD: saves to SD card.

- USB: saves to USB flash

- **BACKUP** (setting of automatic back up)
  - It automatically backs up the data of the capture memory when it stops measuring.
  - SD: OFF: no back up
  - FILE: backs up it to the storage device indicated by "DEVICE".
  - SRAM: backs up the latest 512KB to the internal SRAM of the analyzer.
  - 📖 When set to SRAM, it reloads the data when the power turns on.

- **AUTOSAVE**(Logging Function for a Long Time)
  - This function saves data being measured onto a SD card or a USB flash.

📖 6.5 Logging Function for a Long Time

## 📖 RECORD&DISPLAY CONTROL(Record and Display Setting)

Sets additional information recorded with the data transmitted and received during the measurement.

Each kind of data is measured and recorded with the following settings of when the measurement starts.

After the end of the measurement, the data is also displayed according to the initial setting, regardless of the conditions set afterwards.

📖 6.11 Recording Function to Measure Addition Information

- **IDLE TM** (Idle Time Display Function)

The time, when SD and RD keep non-communication status and a changeless status of a signal line, is recorded in the capture buffer. It will be displayed with receipt data.

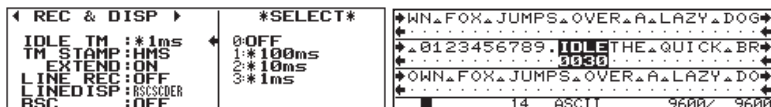

The example indicates there was an idle time of 30 to 30.9ms (at time of setting 1ms)

📖 Time Resolution : 100ms (0 to 999.9S), 10ms (0 to 99.99S), 1ms (0 to 9.999S)

- **TM STAMP**(Time Stamp Function)

The time, when the head of characters of each frame running through the communication channel is received, is recorded in the capture buffer and displayed.



The example indicates that received time of last data was 48min. 32.86 sec (at time of setting MS 10m).

📖 Display Setting : DHM (day, hour, minute) HMS (hour, minute, second), MS 10m (minute, second, 10ms)

- **LINE REC**(LineState Display)

The logical state (timing form) of the control lines and the data of SD/RD (one line for each) are displayed simultaneously.

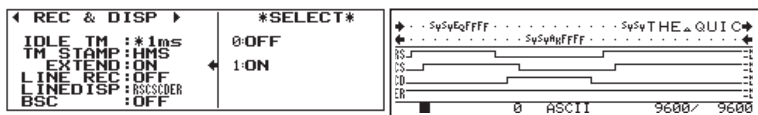

The timing display presenting the signal condition of Line State LED's lights-on is given with logic H and that of its lights-out with logic L.

📖 Display Setting : OFF, ON

- **LINEDISP**(Control Line Display Selection)



Four lines can be selected for the line state display.

Enter the corresponding number to select the line state.

📖 "EX" displays the logic state of TTL level from the external input "TRIGGER INI".

📖 "SQ" is for the future use and will not be displayed.

- **BSC**(Frame Translation)



The transmitted/received data can be translated and displayed.

📖 Display Setting : OFF, ON

The conditions of printing can be set.

- The setting should be done before printing out. It is not necessary for the measurement.
- In the case of setting AUX, it will be outputted as serial data through AUX port, following next "AUX CONDITION" setting. (Need to set it when using the optional printer or utility software, "LEPRTIN\_WIN")

REMOTE CONDITION (Remote communication condition setting)

Setting for AUX(RS-232C) port and Wi-Fi communication

AUX

Aux setting for communication speed (SPEED), data bit length (CHAR BIT), parity bit (PARITY), and flow control (X-CONT)

- Set these items depending on those of PC or printer which is to be connected with the AUX port.

← REMOTE COND ▶	*SELECT*
AUX	
SPEED : 115200	0: 9600
CHAR BIT : 8	1: 19200
PARITY : NONE	2: 38400
X-CONT : OFF	3: 57600
W-LAN : OFF	4: 115200
	5: 230400

W-LAN

Set Wi-Fi function from "OFF"(not use Wi-Fi), STA (use through an access point), AP(the analyzer will be access point)

- Wi-Fi function is available only in Japan, USA, Canada, and EU nations where the product is needed to be compliant with RE directive (2014/53/EU).
- The analyzer corresponds with IEEE802.11b/g/n.
- You cannot remotely connect to the analyzer by AUX or USB while connecting by Wi-Fi.
- Wi-Fi setting is reflected by pushing [ENTER]. Push [ENTER] when you finish the Wi-Fi setting such as SSID.

← REMOTE COND ▶	*SELECT*
AUX	
SPEED : 115200	0: OFF
CHAR BIT : 8	1: STA
PARITY : NONE	2: AP
X-CONT : OFF	
W-LAN : STA	
PUSH PAGE DOWN	PUSH ENTER TO APPLY

Item	Description
SSID	Identifier of the access point
PASSWORD	Security key (encryption key)
DHCP	ON/OFF of DHCP
IP-ADDR	IP address of the analyzer
NETMASK	Subnet mask of the analyzer
GATEWAY	Default gateway
PORT	Port number of the analyzer to be connected

← REMOTE COND ▶	[STATION]
*SECURITY: WPA/WPA2	
SSID :	
PASSWORD :	
IP-ADDR : 0. 0. 0. 0	
NETMASK : 0. 0. 0. 0	
GATEWAY : 0. 0. 0. 0	
PUSH PAGE UP/DOWN	PUSH ENTER TO APPLY

← REMOTE COND ▶	*INPUT*
PORT : 10101	SET SERVER PORT
PUSH PAGE UP	(1~65535) (DECIMAL) PUSH ENTER TO APPLY

< STATION >

- When you connect through internet set GATEWAY.
- The PASSWORD will be shown by ● after entering it thus you cannot confirm the setting
- "IP-ADDR", "NETMASK", and "GATEWAY" are need to be set when DHCP is invalid.

← REMOTE COND ▶	*SELECT*
AUX	
SPEED : 115200	0: OFF
CHAR BIT : 8	1: STA
PARITY : NONE	2: AP
X-CONT : OFF	
W-LAN : AP	
PUSH PAGE DOWN	PUSH ENTER TO APPLY

Item	Description
SECURITY	Select authentication protocol from the followings; OPEN, WPA, WPA2, or WPA/WPA2
SSID	Identifier of the analyzer Initial value is LE_XXXXXXX (XXXXXXX is serial number of the analyzer)
PASSWORD	Security key (encryption key) Initial value is @XXXXXXXX# (XXXXXXX is serial number of the analyzer)
CHANNEL	Channel to be used for Wi-Fi
PORT	Port number of the analyzer to be connected

← REMOTE COND ▶	[AP]
*SECURITY: WPA/WPA2	
SSID : LE_9999999	
PASSWORD : ●●●●●●●●	
CHANNEL : 11	
PUSH PAGE UP/DOWN	PUSH ENTER TO APPLY

← REMOTE COND ▶	*INPUT*
PORT : 10101	SET SERVER PORT
PUSH PAGE UP	(1~65535) (DECIMAL) PUSH ENTER TO APPLY

< AP >

- Set the CANNEL not to interfere with other wireless applications..

## AUTO RUN (Automatic Start and Stop)

Can start and stop measurement repeatedly. Can also be in the RUN state as soon as the power is on.

← AUTO RUN ▶ [10/20 16:58]	*SELECT*
MODE : MONTHLY ←	0:MONTHLY
RUN TIME:OFF	1:DAILY
STOPTIME:OFF	2:HOURLY
P-ON RUN:OFF	

 Using AUTOSAVE with “APPEND ON” is useful.

 6.5 Logging Function for a Long Time (AUTOSAVE)

## TIME & DATE SET

The following procedure should be followed in order to set the built-in clock.

← TIME & DATE ▶ PRESENT [16 10/20 16:58:52]
DATE '16 10/20
TIME 16:58:36
←,→,↑,↓ SELECT & INPUT DATA

1. The current time and the date are displayed in the first line on the screen.
2. Move the cursor to the flashing figure to be changed with [←],[→],[▲] and [▼].
3. Input with [0] to [9].
4. The date is displayed as year(last two figures)/month/day,and time is displayed as hour: minute:second(the 24 hour display).
5. Press [ENTER] to set the new value.  
When you abort the clock setting, press not [ENTER] but [MENU] in order to go back to the top menu screen.

 When the Appointed Time Automatic Start and Stop Function is used, make sure the current time and the date are inputted correctly.

## OTHER FUNCTION

Sets the following: sounding a buzzer, turning off the backlight automatically, battery warning.

### ■ KYESOUND (Key Click Sound Setting)

← OTHER FUNC ▶	*SELECT*
KEYSOUND:ON	SIMULATION
BL OFF : 0	& BERT LOCK
RUN CHK :ON	0:OFF
BATTWARN:ON	1:ON
SIM LOCK:ON	

KEYSOUND means key click sound.

### ■ BL OFF (Backlight Setting)

← OTHER FUNC ▶	*INPUT*
KEYSOUND:ON	SET
BL OFF : 0	BACKLIGHT
RUN CHK :OFF	AUTO OFF
BATTWARN:ON	TIME
SIM LOCK:OFF	(0~60) min
	(DECIMAL)
	0=INFINITE

The time, when backlight is turned off automatically, can be set. If key operation is not executed within set time (from 1 to 60), backlight will be turned off automatically. It will not be turned off automatically, if "0" is input.

 [SHIFT]+[DISPLAY MODE] switches lighting and lights-out

### ■ RUN CHK (RUN key check)

← OTHER FUNC ▶	*SELECT*
KEYSOUND:ON	RUN KEY
BL OFF : 0	CHECK
RUN CHK :OFF	0:OFF
BATTWARN:ON	1:ON
SIM LOCK:OFF	

Displaying the message confirming start of measuring or not when “RUN” key is pressed.

 It may avoid starting measurement by accident and protect the measured data.

### ■ BATTWARN (Operation of While Battery Warning is Active)

← OTHER FUNC ▶	*SELECT*
KEYSOUND:OFF	BATTERY
BL OFF : 1	WARNING
RUN CHK :OFF	ERROR
BATTWARN:ON	0:OFF
SIM LOCK:OFF	1:ON
	2:STOP

Even while battery warning is active, whether or not measuring operation can take place.

 It is possible to continue measuring even during battery warning. However, you are advised to use the AC adapter.

### ■ SIM LOCK (Simulation Lock)

← OTHER FUNC ▶	*SELECT*
KEYSOUND:ON	KEY CLICK
BL OFF : 0	SOUND
RUN CHK :OFF	0:OFF
BATTWARN:ON	1:ON
SIM LOCK:OFF	

Selects ON/OFF of actions of simulation or BERT.

 It prevents a mistaken [RUN] operation from affecting the target line or communication system.

## 2.6 Communication Condition Setting (Configuration)

Your analyzer needs to be set up adjusting communication conditions like communication channels, protocols for tested device, communication speed and so on.

Press [MENU] to display the top menu and then press [0] "CONFIG" to set the communication conditions (configuration).

```

<CONFIGURATION> *SELECT*
PROTOCOL :ASYNC ← 0:ASYNC
S-SPEED  :9600    1:SYNC·BSC
R-SPEED  :9600    2:HDLC·SDLC
CODE     :ASCII   3:ASYNC(PPP)
CHAR BIT :8       4:MODBUS
PARITY   :NONE
PUSH PAGE DOWN  PUSH SHIFT+PAGE DOWN
  
```

```

<CONFIGURATION> *SELECT*
PROTOCOL :HDLC ← 0:ASYNC
S-SPEED  :9600  1:SYNC·BSC
R-SPEED  :9600  2:HDLC·SDLC
CODE     :ASCII  3:ASYNC(PPP)
FCS      :FCS16  4:MODBUS
FORMAT   :NRZ
PUSH PAGE DOWN  PUSH SHIFT+PAGE DOWN
  
```

### Communication Protocol Setting

Select "PROTOCOL" as your target device.

"PROTOCOL"	Communication protocol of target device	Description
ASYNC	Asynchronous	Communications which uses start and stop bits. Ex.) PC COM port, UART communication
SYNC	Character-synchronous	Communications which uses 1 or 2 bytes of characters. Ex.) BSC, JCA procedure etc.
HDLC	Flag-synchronous transmission	Communications which uses flag bit patterns (7Eh). Ex.) HDLC, SDLC, X.25, LAPD
PPP	PPP (Asynchronous typed)	Asynchronous which uses flag characters (7Eh). Ex.) PPP communication used for WAN etc.
MODBUS	MODBUS (ASCII/RTU)	A communication protocol for PLC based on asynchronous communication [LE-3500R]
IrDA	IrDA1.0/1.1 (SIR/MIR/FIR) and ASK	Infrared communication Available with OP-SB6G
I2C	Inter Integrated Circuit communication	Communication between two devices which uses SDA and SCL lines
SPI	Serial Peripheral Interface communication	Communication between two devices which uses MOSI, MISO, and SCK lines
BURST	Clock Synchronous communications	A communication which makes clock when receiving/transmitting communication data

### Communication Condition Settings

Communication condition settings are different for each protocol. Set the necessary conditions.

Item	Description	ASYNC	SYNC	HDLC	PPP	MODBUS	IrDA	I2C	SPI	BURST
S-SPEED	Channel speed on the SD side	●	●	●	●					
R-SPEED	Channel speed on the RD side	●	●	●	●					
SPEED	Bus line speed					●	●	●	●	●
CODE	Display code	○	○	○	○		○	○	○	○
CHAR BIT	Character bit length	●	●							
PARITY	Parity bit	●	●			○				○
STOP BIT	Stop bit	○								
FCS	Frame check			○	○					
CLOCK	Communication clock		●	●						
IDLE MOD	Idle mode			○						
LEADING	The number of starting flag			○						
S-ADDR	SD side frame address			○						
R-ADDR	RD side frame address			○						
SYNC CHR	Synchronism settle character		●							
RST CHAR	Times of synchronism reset character repetitions		●							
REPEAT	Times of synchronism reset character repetitions			○						
SUPPRESS	Suppress character				○		○			
BCC	Block check	○	○							
BGN CHAR	BCC calculation start character	○	○							



Item	Description	ASYNC	SYNC	HDLC	PPP	MODBUS	IrDA	I2C	SPI	BURST
END CHAR	BCC calculation end character	○	○							
ITB CHAR	ITB character	○	○							
TRANSPRT	Transparent mode	○	○							
DLE CHAR	Data Link Escape character	○	○							
SEQUENCE	Character bit transmission sequence	○	○							●
FRM TIME	Frame end judgment time	○								○
FRM END	Frame end character	○								
FORMAT	Transmission code setting		●	●						
FRAME	Frame translation setting			○						
PACKET	Packet translation setting			○						
MODE						●				
SIM MODE								○	○	
ADDR BIT								○		
SLAV ADDR								○		
CPOL									●	
CPHA									●	

- ☰ ● is necessary to set. ○ is needed to be set in some measuring conditions and test conditions.
- ☰ When communication conditions to measure are unknown, "AUTO CONF" can be selected.
- ☰ Read each instructin manual of expansion kit for "IrDA", "I2C", "BURST" and "SPI".
- ☰ Read "Instruction Manual for Additional Protocols" in the utility CD for "MODBUS".

Move the cursor "←" by [ ▼ ], [ ▲ ], [PAGE DOWN], [PAGE UP] and select the item by [◀], [▶], [0] ~ [F].

#### ■ S-SPEED

Sets communication speed on the side of SD.

- ☰ When data is transmitted synchronizing an external clock, it will be invalid.
- ☰ Max communication speed is different in each model.

📖 9.2 Communication Clock

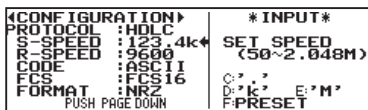

Press [F] to set any speed (any 4 digit number).

When "S-SPEED" is set, "R-SPEED" is automatically set.

Ex. of setting speed

123.4Kbps : Input [1], [2], [3], [C](.), [4], [D](k)

#### ■ R-SPEED

Sets communication speed on the side of RD.

#### ■ SPEED

Sets bus communication speed of the target.

#### ■ CODE

Sets a character bit length. Only the bit length allowed for the display code may be set.

📖 9.4 Data Code Table

#### ■ CHAR BIT

Sets a character bit length. Only the bit length allowed for the display code may be set.

- ☰ HDLC and SLDC are fixed as 8 bits.

#### ■ PARITY

Sets parity bit and multi-processor bit.

- ☰ MP is used as communication adding 1 bit data instead of parity bit.
- ☰ The following can be selected: NONE, ODD, EVEN, MARK(1) and SPACE(0)..
- ☰ SYNC : When a character bit length is set as 6 or 8 bits, only PARITY NONE can be set.

#### ■ STOP BIT

Sets a stop bit length. After being set, stop bit will be added to transmission data during simulating.

- ☰ For received data, checking start bit will be executed after 1 bit without depending on the setting.

#### ■ CLOCK

Selects a synchronism clock for transmitting data.

📖 9.2 Communication Clock

- **FCS**  
Sets whether executing the frame check.

  -  Sets the formula ("FSC16", "FSC32"). When "OFF" is selected, frame will not be checked.

 9.1 Calculation of Block Check
- **IDLE MOD**  
Selects "MARK" or "FLAG" for the idle condition between transmission frames when simulating.
- **LEADING**  
Sets the number of leading flags to transmit when simulating. Normally sets 1. (can be set 1-10)
- **S-ADDR**  
When you want to monitor only a specific frame on the SD side, set the frame address (8-bit data immediately after the flag).  
When don't care "\*" is set, it receives all frames.
- **R-ADDR**  
Sets a frame address on the RD side like S-ADDR is done.

  -  The "S-ADDR" and "R-ADDR" items do not work on the data sent by the analyzer in the simulation function.
- **SYNC CHR**  
Sets one or two synchronous settle characters in HEX.

  -  Default is "16h 16h". It can be "32h 32h" etc. in the case of using EBCDIC code.
  -  Higher bit than a bit length set in "CHAR BIT" will be invalid. If you set a parity bit, synchronous is settled when characters with the parity bit are received. For example, if you set 7 bit data, parity "EVEN", SYNC CHR "1616" or "9696", synchronous is settled when receiving "96h96h" but not settled when receiving "16h16h".
- **RST CHR**  
Sets a synchronism reset character. Default is "FFh" and normally do not need to change.

  -  Higher bits than a bit length to "CHAR BIT" are invalid.
- **REPEAT**  
Sets the number of times of a synchronism reset character. When the set times of synchronous reset characters is continuously received, synchronous is established.

  -  Default is "2" and can be set "1-99".
  -  When "TRANSPRT" is "ON", it will not have the synchronous reset while receiving "BGN CHAR" and "END CHAR"
- **SUPPRESS**  
Sets suppress characters in HEX. When characters set in this section are monitored continuously, the second character and after ones are not stocked in the capture buffer.

  -  Selects "Off" or "On" (flag characters will be the suppress characters) when "PPP".
- **BCC**  
Sets block check code. When "NONE" is set, block check is not executed.

  -  Do not set "CRC-6" or "CRC-12" when total bits of character bits and parity bits are more than 6.

 9.1 Calculation of Block Check
- **BGN CHAR**  
Sets a calculation start character for block check in HEX.

  -  Higher bit than a bit length set in "CHAR BIT" will be invalid.
- **END CHAR**  
Sets a calculation end character for block check in HEX.

  -  Higher bit than a bit length set in "CHAR BIT" will be invalid.
- **ITB CHAR**  
Sets an ITB character in HEX.

  -  Higher bit than a bit length set in "CHAR BIT" will be invalid.
- **TRANSPRT**  
Selects On/Off of transparent mode to calculate.

 9.1 Calculation of Block Check
- **DLE CHAR**  
Sets a DLE character for transparent mode in HEX.

■ SEQUENCE

Sets bit sequence.

<LSB FIRST>

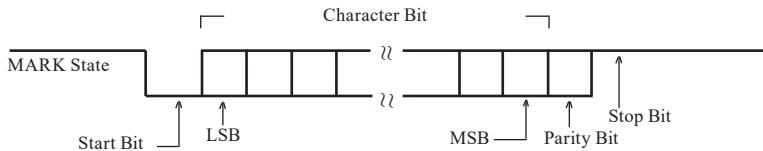

<MSB FIRST>

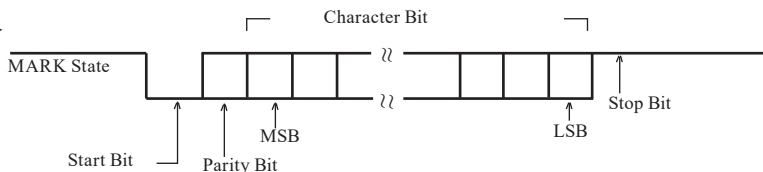

- ☞ During ASYNC, only when parity is included, start bit and stop bit are added. During SYNC, they are not added.
- ☞ In order to check normal protocols except for some ones, "LSB FIRST" needs to be set.

■ FRM TIME

Sets the time of non-communication state which is judged as a frame end at between 1ms and 100ms.

- ☞ Default is 5(ms). Sets the bigger number when measuring low speed data or data with few time stamp.

■ FRM END

Sets the frame end characters up to 2 characters in HEX.

- ☞ Default is "None" and frame ends at the time set in "FRM TIME".

■ FORMAT

Selects the format of communication signals. Default is "NRZ".

- ☞ Can select "NRZ" or "NRZI" when "SYNC".
- ☞ Can select "NRZ", "NRZI", "FM0" or "FM1" when "HDLC".

■ FRAME

Sets translation specifications of frame level.

📖 9.5 Specifications of Translation Display

■ PACKET

Sets translation specifications of packet level.

📖 9.5 Specifications of Translation Display

■ MODE

Select the transmission mode of "MODBUS" from "ASCII" or "RTU".

■ SIM MODE

When executing "I2C" simulation, select "MASTER" or "SLAVE" for the analyzer role.

■ ADDR BIT

When executing "I2C" simulation in slave mode, select address bit from 7 bit or 10 bit.

■ SLAV ADDR

When executing "I2C" simulation in slave mode, set the address of the analyzer.

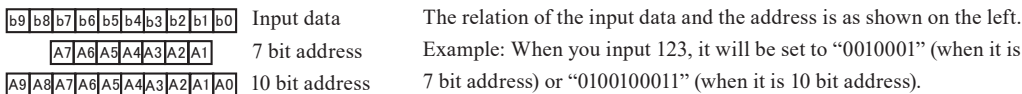

■ CPOL

Setting of the polar character of the "SPI" clock

■ CPHA

Setting of the phase of the "SPI" clock

< The timing of SPI clock and data >

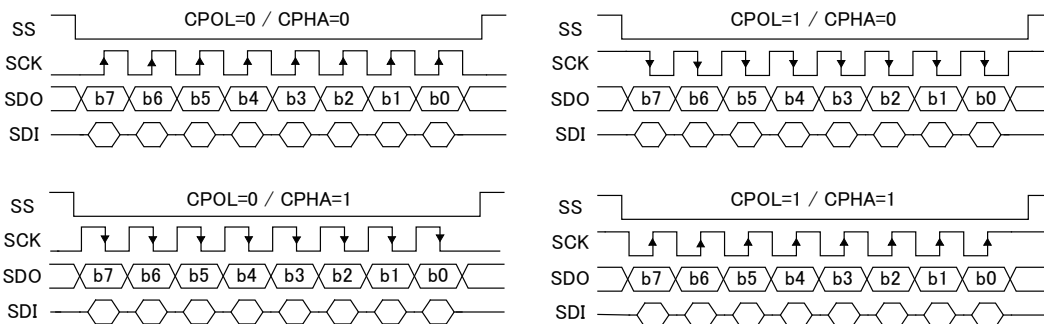

# Chapter 3 Monitor Function

The purpose of the monitor function is to record communication data into the capture buffer without impacting on a communication channel. Also, it is to display clearly following each communications protocol. Not only communication data but also time stamp for data frame and idle time are recorded. As a result, error time and time out conditions are investigated. Moreover, the trigger function, which detects specific communication conditions, and filter function for specific address frame, which makes a memory effectively used, are included.

## 3.1 Online Monitor Function (ONLINE)

### Setting



Move “▶ ◀” to “ONLINE” on the top menu screen. Configuration (communication conditions) needs to be set in advance.

2.6 Communication Conditions Setting

### Operation

To start measurement, press [RUN]. And, the RUN LED is lit. Then, data will be stocked into the capture buffer with it displayed on the screen. One set of two lines of transmission and reception data is displayed. And SD data is displayed on “▶” and RD data is displayed on “◀”.

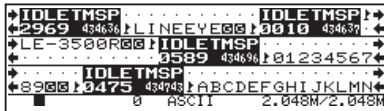

Ex.) When measuring on RS-232C port

- “▶” Row Data inputted from RS-232C port Pin 2 (SD)
- “◀” Row Data inputted from RS-232C port Pin 3 (RD)

When SD and RD are generated at the same time, they are displayed on the same column. “█” is the mark to indicate the place which new data is displayed at. And data on the left side of this mark is new one (displayed only during RUN).

### Error Data and Special Character

Code	Name	Meaning
PE	Parity Error	Displayed when parity is incompatible.
FE	Framing Error	Displayed when stop bit is “0.”
PF	Parity & Framing Error	Parity error and framing error are generated at the same time.
OE	Overrun Error	Displayed when your analyzer cannot process data.
SF	Short Frame	Displayed when the frame length is short through HDLC.
B	Break	Displayed when all of start bit, character bit, (parity bit), stop bit are “0.”
A	Abort	Displayed when 7 bits or more of “1” are detected through HDLC. <sup>(*)</sup>
G	Block Check Code (Normal)	Displayed when BCC or FCS is normal.
E	Block Check Code (Abnormal)	Displayed when BCC or FCS is abnormal.
▶	SDLC/HDLC Flag	Displayed when flag pattern (7Eh) is detected.
03	Multiprocessor Bit	Displayed when multiprocessor bit is “1.” *
I	I2C Start Sequence and I2C Restart Sequence	Displayed when detecting start sequence or restart sequence in I2C
P	I2C Stop Sequence	Displayed when detecting stop sequence

\*1 :About (ABORT) character on RS-485 line  
On an RS-485 half-duplex line, if the line goes into a high-impedance state within 8 bit time after the completion of HDLC (NRZI) frame transmission, the line may go into the state. In an actual communication system, such an ABORT frame will be discarded and no error will occur.

To stop measurement, press [STOP].

- When [ENTER] is pressed, the motion on the display screen temporarily seems stopped while measurement has continued even after being pressed.
  - ☞ The RUN LED remains lighting.
  - ☞ Operations like capturing data, a trigger, and etc. are not influenced.
  - ☞ During screen being stopped temporarily, "PAUSE" will be displayed at "FUNCTION" part of state display on the last line of the screen.
- In order to toggle this state, press [ENTER] again.
  - ☞ "PAUSE" will be not displayed at "FUNCTION" part of state display on the last line of the screen.

## 3.2 Analog and Delay Time Function

DELAY function simultaneously supplies two functions:

1. Measure the delay time between one condition of the interface signal and the another.
2. Measure the voltage (MAX. MIN. Current) of the signals of RS-232C or TTL.

### Setting

- Sets the start/stop conditions of delay time. When measuring RS-232C, do not need to set this.

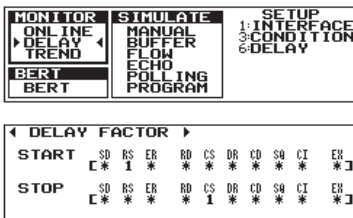

Move ► ◀ to "DELAY" on the top menu screen.  
To select "DELAY" on the setup window, press [6] or [Enter].

Set the start/stop conditions of delay time by setting nine signals (SD, RS, ER, RD, CS, DR, CD, CI and EX (external signal)). Set them with [1](ON), [0] (OFF), [X](don't care) moving a cursor with[◀] [▶],[▲] ,[▼]

- ☞ ON state : RS-232C voltage level is +3 or higher (space).
- ☞ OFF state : RS-232C voltage level is -3 or lower (mark or NC).
- ☞ Although SQ is displayed on the screen because of compatibility with old models, the setting will be ignored.

### Action

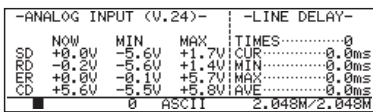

Press [RUN] to display the value of voltage measured (ANALOG INPUT VOLTAGE) and the delay time of the interface signals(LINE DELAY) in real-time.

#### Delay Time Measurement

Delay time means the time between the start and stop condition of the signals at the resolution of 0.1ms.

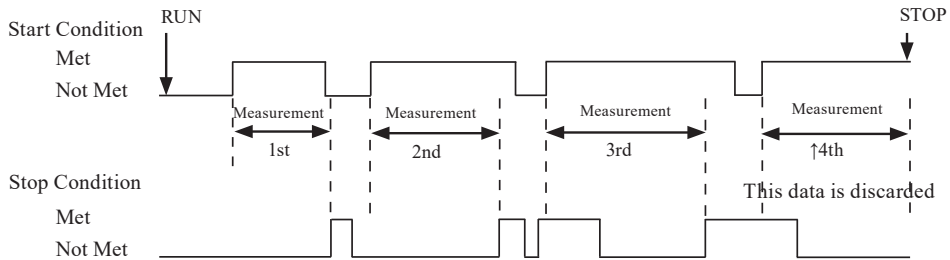

- ☞ The start/stop conditions are established when the nonconformity of the two conditions becomes the conformity of those. Thus, start/stop conditions will not be established when they are conformed from the beginning.
- ☞ The change of signals within 0.1 ms cannot be sometimes detected.

### Display

- Display of the signal voltage measured in RS-232C level
  - shows simultaneously the voltage values of the current , MAX and MIN of each signal of SD,RD,ER and CD.
  - ☞ The signal input range is -/+15V, and the resolution is 0.1V.
- Display of delay time
  - shows the delay time between start and stop condition of the current value, Max, Min, Average and number of times (how many times).
  - ☞ When the value at "CUR" is over the signal input range, "OVER FLOW" is displayed. If the start condition is established again, the counter is cleared and measurement will start again. However, the value of MAX and average are not assured.

### 3.3 Statistical Analysis Function (TREND) [LE-3500R]

The statistical analysis function is capable of counting the occurrence of the events such as the number of characters and frames in a specific period, and displaying the result on graph to check how the occurrence of them changes over time. This function helps you to check the frequency of the use of a channel and the like.

#### Setting



Move ► ◀ to "TREND" on the top menu screen.

To select "TREND" on the setup window, press [7] or [Enter].

Configuration (communication conditions) needs to be set in advance.

2.6 Communication Conditions Setting

#### ■ "EVENT:"

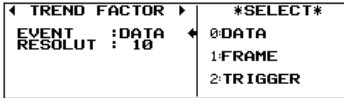

9.3 Frame

6.1 Trigger Function

Select an object you wish to measure to calculate using [0]~[2].

[0]DATA : The number of the characters which has been monitored on the SD and RD side.

[1]FRAME : The number of the frames which has been monitored on the SD and RD side.

[2]TRIGGER : The number of the events which satisfies the trigger condition being set for "FACTOR" of "TRIGGER 0" and "TRIGGER 1" on the trigger screen.

The "ACTION" function of "TRIGGER" does not operate.

#### ■ "RESOLUT:"

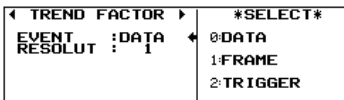

Set a resolution, unit time for statistical processing, at the range from 1 to 240 min. on a horizontal scale of a graph with [0] to [9].

Statistically processed data up to Max. 2000unit time can be recorded.

#### Starting and Ending Measurement

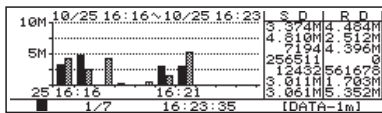

To start measurement, press [RUN]

The statistical processing screen will be displayed.

As unit time of statistical processing passes, the results of calculated value will be updated on a bar graph.

#### ■ Changing the range of a vertical scale

To change a resolution on a vertical scale, press [DISPLAY MODE] .

#### ■ Ending

After 2000 times statistics are done, measurement will end automatically.

To stop measurement halfway, press [STOP] . This statistic is calculated based on the data till [STOP] is pressed.

The AUTO RUN function allows measurement for a desired length of time.

#### Display and Printing

#### ■ Screen Scroll

Scroll the results by [◀], [▶], [PAGE UP], [PAGE DOWN] after the measurement.

[◀], [PAGE UP] :Go back to the data on earlier time.

[▶], [PAGE DOWN] :Go to the data on later time.

Display the beginning/ end of data by pressing [TOP/DEL]/ [END/X].

#### ■ Printing of the statistic value

After finishing measurement, press [PRINT] at the graph print screen. And select the print type by pressing [◀] or [▶], then press [ENTER].

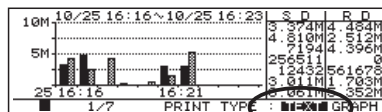
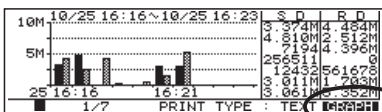

## Chapter 4 Simulation Function

The simulation function is the tool that makes your analyzer operate as a device communicated by tested devices, and that executes a test for transmission and reception following protocols.

Even if communicated devices are not prepared at the first step in developing, the testing like real operation will be able to be executed. After checking communication procedure in our original "MANUAL mode," complicated communication procedure with conditional branches will be able to be tested by command-selected easy programming. A margin can be evaluated at staggered communication speed on purpose because appointed communication speed can be set. Moreover, error processing response can be checked with tested data which includes parity error data.

### ■ MANUAL Mode

Registered data of the transmission table corresponding to operation keys [0] to [F] is transmitted one touch every time each key is pressed. Communication procedure can be easily tested with the trigger function checking response from the developed devices through the monitor function. In addition, by pressing [SHIFT] and one key from [0] to [D] fixed data corresponding to each key can be transmitted. Also, pressing [SHIFT] and [E],[F] makes the signal line of RS/CS or ER/CD set ON/OFF.

### ■ FLOW Mode

As a transmitter or a receiver, X-ON/OFF flow control and control line handshake can be simulated. In the transmission mode, the number of transmission data for sixteen times can be displayed from a start to an interrupt request. On the other hand, in the reception mode, two things can be appointed. One is the number of reception data of until an interrupt request is submitted for transmitting. The other is time of until a start request is submitted for transmitting.

### ■ ECHO Mode

Reception data is turned back in your analyzer. It is used for testing a display terminal and a communications terminal.

### ■ POLLING Mode

The slave side or the master side based on polling communication procedure of multidrop (1:N connection) is simulated. In the slave mode, the number of frame reception times and an error is checked at the self-address. And then, appointed data is replied. In the master mode, polling messages are transmitted to 32 kinds of the slave addresses. And then, response data is checked in each slave address.

### ■ BUFFER Mode [LE-3500R]

The transmission side or the reception side is selected from transmission/reception data stocked into a memory through the monitor function. And then, that data is transmitted as simulation data. It is useful to perform a reproducing test for data with the same communication state monitored in the field.

### ■ PROGRAM Mode [LE-3500R]

By programming for a dedicated command, communications protocol involved in the conditional judgment is flexibly simulated. There is the selectable menu for programming so it is easy to master this mode.

## 4.1 Preparation for Simulating

### Registration of Transmission Data (DATA TBL)

At the time of using the simulation function, transmitted data is registered.

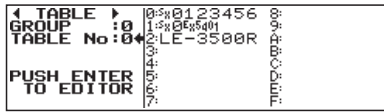

Select "DATA TBL" ( [9] ) of the setup menu in the simulation. Transmission data table has 160 kinds from No.00 to No.9F. The total of it can be set up to max. 16384 characters.

If there is data registered in each table, the first eight characters will be displayed.

#### <Data to be Registered>

The characters, which are inputted and displayed, are treated as the code being set on a data code (CODE: item) of the configuration menu. After setting required data code, inputting and editing should be executed. And, on the display screen for registering transmission data, the character display cannot be changed by SHIFT IN and SHIFT OUT. Parity bits, synchronism characters, reset characters and synchronism flags are added and transmitted automatically. Therefore, they need not to be included in registered data.

The effective data entered is only bit which is set in the character bit length. Others at higher positions are ignored.

#### <Method of Registration>

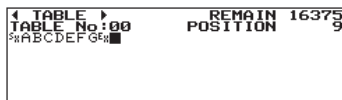

Enter the table group (GROUP) and table number to be set and changed. Then, press [Enter] to display the data entry screen.

Registered data will be displayed on the screen. A cursor position is where "■" is blinking. "REMAIN", which indicates the rest of buffer for transmission data, will appear on the upper right of the screen. And also, "POSITION", which indicates the cursor position, will appear below "REMAIN".

#### 1. Data Entry

Move a cursor where you wish to enter data using a cursor key. A cursor position is the place which "■" is blinking at. To modify or add entered data, move the cursor to the position and enter the characters. To delete it, move the cursor where you wish to delete it, and press [TOP/DEL]. Then, it will be deleted, and the characters after the deleted character will be moved forward. An input is executed in HEX or character.

2.4 Character Input

#### 2. BCC and FCS Addition

If setting other than "NONE" in "BCC" item or "FCS" item at Configuration, calculation for BCC or FCS will be executed by pressing [SHIFT] + [ENTER] after finishing inputting. Finally, BCC or FCS will be inserted. In the case of BCC, BCC will be inserted after "END CHAR" because a calculation, which is between "BGN CHAR" and "END CHAR" that is set in the configuration, is executed.

eg.)

#### ◆ Configuration Setting (ASCII)



BCC :Sets "LRC ODD"  
BGN CHAR :Sets "(02h)"  
END CHAR :Sets "(03h)"

#### ◆ Register data in the data table

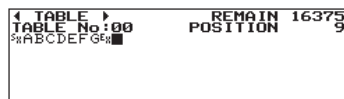

"<sup>S</sup><sub>X</sub> ABCDEF G <sup>E</sup><sub>X</sub>" is registered to TABLE No.00.

#### ◆ Executing a Calculation of BCC

Press [SHIFT] + [ENTER] on the display screen of the data table.

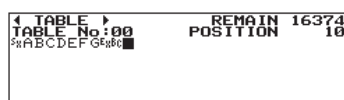

BCC is calculated between "(02h)" and "(03h)," and then BCC (BCh) is inserted behind "(03)" = "EX."

In order to modify data which has been calculated as BCC (FCS), or the setting of BCC (FCS), press [SHIFT] + [ENTER] to recalculate. Then, recalculated BCC (FCS) will be overwritten and appear.



### 3. Parity Error and Multiprocessor Setting

At first, move a cursor where you want parity error to be generated or where you want multiprocessor bit to be set to 1. And then, press [SHIFT] + [E]. The setting will be completed.

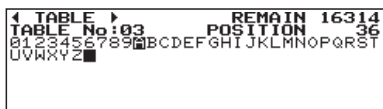

eg) The setting of “A”

Move a cursor to “A” and press [SHIFT]+[E].

A highlighted “A” will be displayed.

After setting, highlighted characters will be displayed. In order to undo this, press [SHIFT]+[E] again.

<Method of Useful Data Editing>

#### ■ Inputting Altogether (Copy)

This is the function to input plural characters once or repeatedly by copy and paste.

eg) Copying characters from A to L, and inputting them altogether

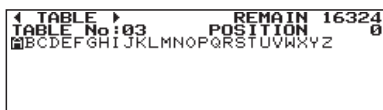

① Select the first character with a cursor and press [ENTER]. “SIZE” will appear on the upper right of the screen instead of “REMAIN.” And then, as the cursor is moved with characters selected, the number of selected characters will be displayed next to “SIZE.”

② Move the cursor from “A” toward “M” using a cursor key, selecting letters.

\* In this case, the cursor on “M” is blinking.



③ To register letters from “A” to “L,” press [END/X]. They are registered in an editing memory.



④ Press [END/X] again to paste.

Registered data will be inserted to the next part of the cursor position.

After this, unless it is changed, it will be pasted repeatedly as [END/X] is pressed.

There is capacity for 256 characters in an editing memory. When more than that is registered, 257th character and afterwards are truncated.

#### ■ Deleting Altogether

This is the function to delete plural characters at the same time.

① Select the first character with a cursor and press [ENTER]. “SIZE” will appear on the upper right of the screen instead of “REMAIN.” And then, as the cursor is moved with characters selected, the number of selected characters will be displayed next to “SIZE.”

② After a cursor is moved where to be deleted, press [TOP/DEL]. The highlighted character string but last blinking character will be deleted. Deleted characters are registered in an editing memory. Therefore, even when they are needed after deleted, [END/X] will help you to let them appear again.

(Possible to register up to max. 256 characters)

#### ■ Copying Table Data

To use the special editing functions “COPY TABLE,” press [SHIFT]+[MENU] on the data entry screen.

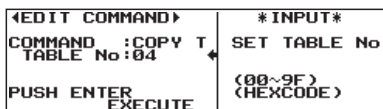

① Select “COPY TABLE.”

And press the table No. to be copied.

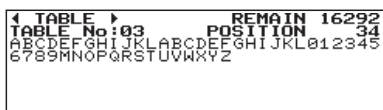

② Press [ENTER].

Then, data of the selected table No. will be added to the previous part of a cursor position on the character.

Above the screen indicates that the data from “A” to “Z” is registered in TABLE0 and also the data from “0” to “9” is registered in TABLE2, and then that a cursor has been moved to “O” and data in TABLE2 has been copied and pasted there.

■ Copying Buffer

To use the special editing functions “BUFFER COPY,” press [SHIFT]+[MENU] on the data entry screen.

1.The head of data to be copied is adjusted on the upper left of the display screen of monitored data scrolling.

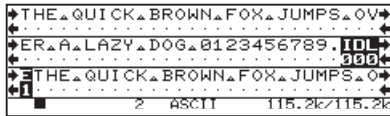

EDIT COMMAND		*SELECT*
COMMAND	:COPY B	0: COPY TABLE
SOURCE	:SD	1: COPY BUFFER
SIZE	: 256	2: FILL
PUSH ENTER		
EXECUTE		

2.Select “COPY BUFFER” and select the SD side or the RD side.

3.Set the number of the characters to “SIZE” item.

4.Press [ENTER]. The number of the characters appointed from that data will be inserted behind the cursor position.

- ☞ It is copied. IDLE TM and TM STAMP are ignored.
- ☞ When transmission data table is full, operation will stop.

■ FILL

Data from characters appointed in “BEGIN” to ones appointed in “END” can be inputted for the number of the characters inputted in “SIZE.”

EDIT COMMAND		*INPUT*
COMMAND	:FILL	SET FILL SIZE
BEGIN	: 00	
END	: 03	
SIZE	: 8	(1~16384) (DECIMAL)
PUSH ENTER		
EXECUTE		

eg.)  
 BEGIN : 01  
 END : 03  
 SIZE : 08

Press [ENTER]. Then, the following data will be inputted at a cursor position.

01 02 03 01 02 03 01 02

If BEGIN < END, a character from BEGIN toward END will be inputted increasing one by one till the number of a character set in “SIZE” is filled.

If BEGIN > END, a character from BEGIN toward END will be inputted decreasing one by one till the number of a character set in “SIZE” is filled.

If BEGIN = END, a common character set in both BEGIN and END will be inputted till the number of a character set in “SIZE” is filled.

When the transmission data table is full, operation will stop.

■ Fixed Transmission Data

Special characters like ENQ, ACK, etc. can be inputted with [SHIFT] + one key from [0] to [D] . They are inputted in data code being set in the configuration.

[SHIFT]+[0]	:ENQ	[SHIFT]+[7]	:RVI
[SHIFT]+[1]	:ACK	[SHIFT]+[8]	:TTD
[SHIFT]+[2]	:NAK	[SHIFT]+[9]	:‘ FOX ’ Message (*1)
[SHIFT]+[3]	:WACK	[SHIFT]+[A]	:‘ MSG1 ’ Message (*2)
[SHIFT]+[4]	:EOT	[SHIFT]+[B]	:‘ MSG2 ’ Message (*3)
[SHIFT]+[5]	:ACK0	[SHIFT]+[C]	: DC1(11H)
[SHIFT]+[6]	:ACK1	[SHIFT]+[D]	: DC3(13H)

\*1 ‘FOX’ :THE QUICK BROWN FOX JUMPS OVER A LAZY DOG 0123456789.

\*2 ‘MSG1’:SX0123456789ABCDEFGHIJKLMNPNOPQRSTUVWXYZ<sup>Ex</sup> **BCC**

\*3 ‘MSG2’:0123456789ABCDEFGHIJKLMNPNOPQRSTUVWXYZ **C<sup>R-F</sup>**

◆ The values (hexadecimal) corresponding to entries of the keys [SHIFT] + one key from [0] to [B] vary depending on the setting for data code of the configuration.

◆ Characters, which are not defined in the code table, are ignored.

◆ Entries with the keys [SHIFT] + one key from [0] to [8] cause the following values to be set.

	ASCII(JIS)	EBCDIC(EBCDIK)	Transcode	Others
ENQ	05	2D	2D	-
ACK	06	2E	3C	-
NAK	15	3D	3D	-
WACK	10•3B	10•6B	1F•26	-
EOT	04	37	1E	-
ACK0	10•30	10•70	1F•20	-
ACK1	10•31	10•61	1F•23	-
RVI	10•3C	10•7C	1F•32	-
TTD	02•05	02•2D	0A•2D	-

Select the method to control RS-422/485 transmission driver IC when simulating on RS-422/485 port.

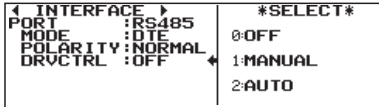

Set "DRVCTRL" item of "INTERFACE" ([1]) on the top menu screen.

2.2 Set the Measurement Port (INTERFACE SETUP)

**OFF** : Select when testing RS-422, X.20/21, RS-449 and V.35 in full duplex. Driver IC will always be in an enable state after starting test.

**MANUAL** : When ER (DTE) or CD (DCE) is ON, the driver will be in an enable state. And when ER (DTE) or CD (DCE) is OFF, the driver will be in disable (high impedance) state. It is used to control driver IC by setting ON/OFF of ER and CD in MANUAL or PROGRAM mode.

- When "LINECTRL" is set ON, the driver IC will be controlled
- When "LINECTRL" is set OFF, the initial state of ER (DTE) or CD (DCE) at the start of simulation is as follows:

Simulation mode	Initial State of Driver
MANUAL Mode	High impedance state
FLOW Mode	Enable
ECHO Mode	Enable
POLLING Mode	Enable
BUFFER Mode	Enable
PROGRAM Mode	High impedance state

**AUTO** : Select "AUTO" when testing RS-485 in half duplex. The driver automatically becomes "Enable" only while transmitting the test data, and the driver will automatically become "Disable" after about 1 to 3 bits is delayed after data transmission. However, because of the processing time, there is a delay of 400u seconds at least.

Terminator for RS-422/485 Port

When a simulating test for transmission/reception is executed through RS-422/485 port, also when your analyzer is put at a terminal position of communication for one to one communication, the terminator need be connected. In general, at the time of RS-422, the terminator only of the input signal line on your analyzer is connected. Moreover, at the time of RS-485, the terminators of all the signal lines on your analyzer are connected.

2.3 Connect to the Target Devices

Method of connecting terminators

Take out the interface sub-board and set the jumper to "1" side to connect the terminator. JP1 is the jumper pin of the terminator for TXD side and JP2 is for RXD side.

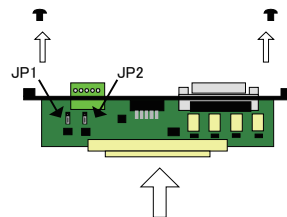
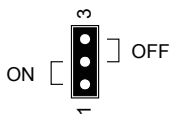

[Method of taking out and inserting interface sub boards]

- ① At first, screw a sub board off, and take it out.
- ② Set the jumper.
- ③ Finally, insert the sub board into a slot, and screw it on.

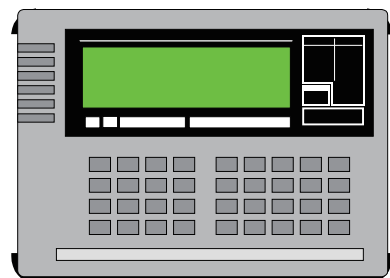

## Controlling a Control Line (LINECTRL)

The signal state of control lines (RS, ER, CS, CD) and timing of data transmission can be controlled automatically when simulating. Depending on the interface mode (DTE/DCE), the action will be different.

Press [Menu] -> [1]"INTERFACE" and set "MODE" to "DTE" or "DCE". To have automatic control of control lines, set "LINECTRL" to "ON".

Automatic control will not be operated if setting "LINECTRL" to "OFF".

### DTE

```

┌ INTERFACE ──┐          *SELECT*
PORT   :RS232C
MODE   :DTE          0:OFF
POLARITY:NORMAL      1:ON
LINECTRL:ON
PUSH PAGE DOWN
    
```

To set following items, press [PAGE DOWN].

```

┌ INTERFACE ──┐          *INPUT*
DELAY TH: 10          SET TIME
RS ON  : 10          (0~9999)ms
SD SEND: 100
RS OFF : 100
ER SW  :ON
PUSH PAGE UP
    
```

Items	Description
RS ON	Time Between the start of transmission operation and RS "ON."
SD SEND	Time between CS "ON" and data transmission to the SD side.
RS OFF	Time between the end of data transmission to the SD side and RS "OFF."
ER SW	ON/OFF of ER signal when testing.

ON: active, OFF: non-active

(Example of Data transmission "ABC")

If set as follows:

```

┌ INTERFACE ──┐          *INPUT*
DELAY TH: 10          SET TIME
RS ON  : 10          (0~9999)ms
SD SEND: 20
RS OFF : 30
ER SW  :ON
PUSH PAGE UP
    
```

[RUN]



```

┌ IDLE IDLE IDLE ABC IDLE IDLE ──┐
└ 0010 0010 0020 0030 0051 ──┘
RS
CS
CD
ER
    
```

0 ASCII 9600/9600

Target device (DCE) makes CS "ON" after 10 seconds from RS "ON". And it makes CS "OFF" after 51 seconds from RS "OFF".

### DCE

```

┌ INTERFACE ──┐          *SELECT*
PORT   :RS232C
MODE   :DCE          0:OFF
POLARITY:NORMAL      1:ON
LINECTRL:ON
PUSH PAGE DOWN
    
```

To go to the screen for setting the control line, press [PAGE DOWN].

```

┌ INTERFACE ──┐          *INPUT*
DELAY TH: 10          SET TIME
CS ON  : 10          (0~9999)ms
CD ON  : 100
RD SEND: 100
CD OFF : 100
PUSH PAGE UP
    
```

Items	Description
CS ON	Time between RS "ON" and CS "ON."
CS OFF	Time between RS "OFF" and CS "OFF."
CD ON	Time between the start of transmission operation and CD "ON."
RD SEND	Time between CD "ON" and the start of data transmission to the RD side.
CD OFF	Time between the end of data transmission of the RD side and CD "OFF."

ON: active, OFF: non-active.

```

┌ INTERFACE ──┐          *INPUT*
DELAY TH: 10          SET TIME
CS ON  : 10          (0~9999)ms
CD OFF : 51
RD SEND: 100
CD ON  : 100
CD OFF : 100
PUSH PAGE UP
    
```

```

┌ INTERFACE ──┐          *INPUT*
DELAY TH: 10          SET TIME
CS ON  : 10          (0~9999)ms
CD OFF : 30
RD SEND: 5
CD ON  : 5
PUSH PAGE UP
    
```

```

┌ INTERFACE ──┐          *INPUT*
DELAY TH: 10          SET TIME
CS ON  : 10          (0~9999)ms
CD OFF : 50
RD SEND: 30
CD ON  : 30
CD OFF : 50
PUSH PAGE UP
    
```

## 4.2 MANUAL Mode

Data for the data table corresponding to each key will be transmitted by pressing a key.

### Setting



Move “▶ ◀” to “MANUAL” on the top menu screen ([MENU]).  
Set the configuration (communication condition) in advance.

2.6 Communication Condition Setting

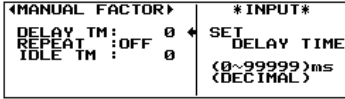

To select “MANUAL,” press [A] or [ENTER].

■ Set the following items below.

Items	Description	Range of Selection
DELAY TM	Space between characters	0 to 99999 1msec. unit
REPEAT	Repetitive transmission of frame	ON/OFF
IDLE TM	Interval of repeat transmission	0 to 99999 1msec. unit

Set 0 to DELAY TM through the others except for ASYNC and ASYNC (PPP).

### Operation

① Pressing [RUN] makes the following control lines active. Also, the data display screen will appear. After that, it will be in a wait state till the key corresponding to the transmission data table number is entered.

	“LINECTRL”=OFF	“LINECTRL”=ON
“MODE”=DTE	RS(RTS), ER(DTR)	ER(DTR) “ER SW”=ON
“MODE”=DCE	CS(CTS), DR(DSR), CD(DCD)	DR(DSR)

② Enter a data table number (0-F). Entering it makes registered data corresponding to the data table transmitted. The data group to be transmitted can be changed by [SHIFT] + [▶] or [◀]. Make a protocol flow, checking the transmission and reception data.

- ◆ When ON is set to "REPEAT", data corresponding to the data table will be transmitted continuously spacing for idle time.
  - If Table B is selected to send while Table A is sending, transmission of Table B will start after finishing transmission of Table A.
  - Data transmission can be stopped by pressing [TOP/DEL] or sending a data table with no registered data.
  - Even you select "IDLE TIME" to "0", it will take some time for processing.

◆ Press [SHIFT]+ [0]~[D] to send a fixed data table. Press [X] to send a break (ASYNC mode only). Press [SHIFT]+ [E], [F] to set control lines ON/OFF.

Control lines controlled by key operation:

	[SHIFT] + [E]	[SHIFT] + [F]
“MODE”=DTE	RS(RTS)	ER(DTR)
“MODE”=DCE	CS(CTS)	CD(DCD)

4.1 Preparation of Simulating

- Controlling the control lines ON/OFF by pressing [SHIFT]+ [E], [F] does not affect data transmission.
- Data transmission will not start if "MODE" of interface is set to "DTE" and "LINECTRL" to "ON" until CS(CTS) of target device becomes ON,

e.g.) Transmit "ENQ" in DCE mode. When receiving "TEST1 C<sub>R</sub>L<sub>F</sub>", transmit "NG2 C<sub>R</sub>L<sub>F</sub>".

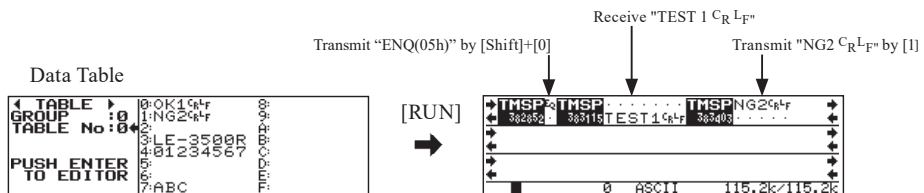

③ Press [STOP] to stop test.

## 4.3 Communication Reproducing Test(BUFFER) [LE-3500R]

Buffer simulation is the mode to send data of the SD/RD side out of data stocked as transmission data in the capture buffer.

### Preparation

Communication data to be simulated is measured and recorded into divided buffer.

←BUFFER SELECT→	*SELECT*
AREA :BUF 1	0:BUF0 OFF
PROTECT :OFF	1:BUF1 OFF
FULLSTOP :OFF	2:BUF2 OFF
DEVICE :USB	
AUTOSAVE :OFF	

Go to “BUFFER SELECT” ( [0] ) of “CONDITION” ( [3] ) on the top menu screen ( [MENU] ). Select “BUF 1” or “BUF 2” from “AREA.” And then, capture buffer will be divided.

- Start measurement.  
Data will be recorded into one of the divided capture buffer.
- End measurement.
- Go back to “AREA” of “BUFFER SELECT” and set the other buffer.  
If “BUF 1” has been already used, “BUF 2” has to be set this time.
- After finishing measurement, it is recommended that contents in buffer memory of the BUF (1 or 2) stocking data are prevented from overwriting the old memory by use of memory write protection function.

### Setting

MONITOR	SIMULATE	SETUP
ONLINE	MANUAL	0:CONFIG
DELAY	▶BUFFER ◀	1:INTERFACE
TREND	FLOW	3:CONDITION
BERT	ECHO	4:WAVE MON
BERT	POLLING	8:BUFFER
BERT	PROGRAM	

Move “▶ ◀” to “BUFFER” on the top menu screen ( [MENU] ).  
Set the configuration (communication condition) in advance.

#### 2.6 Communication Condition Setting

To select “BUFFER,” press [ENTER] or [B].



←BUFFER FACTOR→	*SELECT*
DATA :BUF1SD	0:BUF1 SD
DELAY TM : 0	1: RD
REPEAT :OFF	2:BUF2 SD
IDLE TM : 0	3: RD

- Set the following items below.



Items	Description	Range of Selection
DATA	Transmission Data	BUF1SD:SD side of monitor data for “BUF1”
		BUF1RD:RD side of monitor data for “BUF1”
		BUF2SD:SD side of monitor data for “BUF2”
		BUF2RD:RD side of monitor data for “BUF2”
DELAY TM	Space time between characters	0 to 99999 1msec. unit
REPEAT	Appointing repetitive transmission	ON/OFF
IDLE TM	Space time between frames	0 to 99999 1msec. unit

IDLE TM:Data in capture buffer is divided into frames. And space time at the time of transmitting is appointed.

#### 9.3 Frame

-  DELAY TM is effective only when “PROTOCOL” is “ASYNC.”
-  Frames generating abort through HDLC/SLDC will be transmitted after a flag is added to the position of abort.  
Abort itself will not be transmitted.
-  When one frame is over 4K characters, the frame will be divided (BCC is not added).

### Motion

- ① In order to start simulation, press [RUN].  
Data in capture data, which is appointed in “DATA:” item on the buffer simulation setting screen, is transmitted by one frame unit. Also, simulation results are recorded to the other capture buffer.
- ② Press [STOP].  
Simulation will be stopped.
  -  Parity error and framing error themselves in the capture buffer cannot be outputted for simulation. At the time of errors, values are transmitted as normal data.
  -  BCC (FCS) is not recalculated. Therefore, when character bit length and parity are transmitted as recorded ones with the different setting, the correct codes of BCC (FCS) cannot be transmitted.

- ☐ Once synchronous characters of synchronous (“PROTOCOL”) and the SYNC mode are recorded in a memory, and then if they are changed and set, that motion is not guaranteed.
- ☐ Timing for data transmission will be set based on the setting value inputted in the “DELAY TM” and “IDLE TM” item on the buffer simulation setting screen.
- ☐ If “BUF0” is set to “AREA” item on “BUFFER SELECT” of the condition menu, the warning message will appear and simulation will not be started.

## 4.4 Flow Control Test(FLOW)

In the flow control test, your analyzer works as a transmitter or a receiver. It can transmit data following a control signal. Also, it can receive data returning a pseudo-control signal.

(Control Signal : Control line handshake such as RS, CS, etc. or X-ON/X-OFF code)

### Setting



Move “▶ ◀” to “FLOW” on the top menu screen ( [MENU] ).

Set the configuration (communication condition) in advance.

2.6 Communication Condition Setting

To select “FLOW,” press [ENTER] or [C].

- ☐ Flow Control is available only when "PROTOCOL" in Configuration is set to "ASYNC".

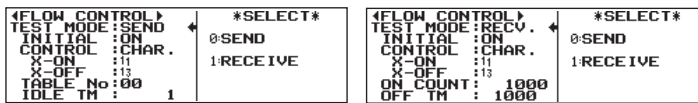

- Set the following items below.

Item	Description	Range of Selection	Remark
TEST MODE	Test motion mode	SEND: Transmission mode (Reception test) RECV: Reception mode (Transmission test)	
INITIAL	Initial state of a control signal	ON/OFF	When “control” is “LINE,” it indicates controlling state. When it is “Char.” it indicates controlling code state.
CONTROL	Control signal selection	CHARACTER/LINE	
X-ON	Requesting code for transmission start	HEX 1byte	Only when “CHARACTER” is selected in “CONTROL.” (*1)
X-OFF	Requesting code for transmission interruption	HEX 1byte	
WATCH	Monitoring control line	CS/RS CD/ER	Only when “LINE” is selected in “CONTROL.”
OPERATE	Operating control line	RS/CS ER/CD	
TABLE No	Transmission table No..	00~9F	Only when “SEND” is set to “TEST MODE.”
IDLE TM	Transmission character space	0 to 99999 1msec. unit	
ON COUNT	The number of a reception character of until interruption request is transmitted from starting	1~999999	Only when “RECV” is set to “TEST MODE.”
OFF TM	Starting request for transmission + Response time	0 to 99999 1msec. unit	

\*1 If the same codes are set in both X-ON and X-OFF, normal motion is not guaranteed.

- “TEST MODE:”

The motion mode is selected.

- [0]“SEND.” Mode to match data with a control signal and to transmit it from your analyzer.
- [1]“RECV.” Mode to control a control signal while your analyzer receives data.

- “INITIAL”

The initial state of a control signal is set.

- [0]“OFF” Impossible state for transmission.
- [1]“ON” Possible state for transmission.

■ “CONTROL”

Character control or line control is set.

[0]“CHARACTER” Character control is executed.

“X-ON” Requesting code for starting transmission is set.

“X-OFF” Requesting code for interrupting transmission is set.

[1]“LINE” Line control is executed.

“WATCH” Signal lines monitored by your analyzer are set.

“OPERATE” Signal lines operated by your analyzer are set.

■ “TABLE No”

Transmission data table number, in which transmission data is registered, is set. At the time of the “SEND” mode, data in the table being set in “TABLE No” item will be transmitted repeatedly.

■ “IDLE TIME”

Space between characters of transmission data is set.

■ “ON COUNT”

The number of the characters, from reception starting to requesting for transmission interruption, is set.

■ “OFF TM”

Time space, from requesting for interrupting transmission to requesting for starting transmission, is set.

 Motion

■ SEND Mode

• Character Control

① After pressing [RUN], set active to both RS (CS) and ER (CD).

② When ON is set to “INITIAL:” item, data will be transmitted soon. When setting OFF, data will be transmitted after X-ON is received.

③ After this, receiving X-OFF makes transmission interrupted, and doing X-ON makes transmission restarted.

• Line Control

① After pressing [RUN], control lines such as RS (CS) and ER (CD), which are set in “OPERATE:” item, are set active.

② After this, if a control line (CS or CD) set in “WATCH:” item is non active, transmission will be interrupted. If it is active, restarting for transmission will be repeated.

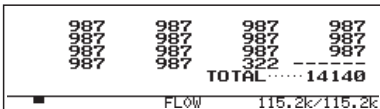

 During testing, the number of data transmitted from starting to interrupting data transmission will be displayed on the screen for sixteen times from starting the test. (When it is over 999999, the message “OVER” will appear there.)

 The number of data for sixteen times will be displayed on “TOTAL” of the lower right of the screen.

 There might be an error +/-3 about the number of count for data.

 [DISOLAY MODE] can help the data display screen appear.

■ RECEIVE Mode

• Character Control

① After pressing [RUN], set active to both RS (CS) and ER (CD).

② Only when OFF is set in “INITIAL” item, X-ON code will be transmitted after time set in “OFF TM” passes.

③ After this, X-OFF code will be transmitted after data set in “ON COUNT” is received. This motion will be repeated.

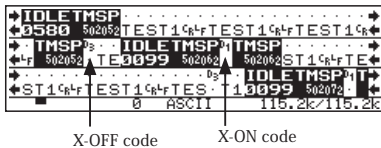

• Line Control

① After pressing [RUN], when ON is set to “INITIAL:” item, a control line, RS (CS) or ER (CD), being set in “OPERATE” item will be active.

② RS(CS) or ER(CD) will be non-active after data set in “ON COUNT:” is received. And RS(CS) or ER(CD) will be active after time set in “OFF TIME” passes. Those motion will be repeated. Transmission / reception data will be displayed in real time during testing.



## 4.5 Echo Back Test (ECHO)

- The echo back test is the function that makes received data repeatedly transmitted from your analyzer.
  - This function cannot be used if "PROTOCOL" is set to "I2C" or "IrDA" at Configuration.

### Setting



Move "▶" "◀" to "ECHO" on the top menu screen.  
Set the configuration (communication condition) in advance.

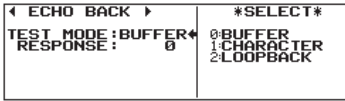

### 2.6 Communication Condition Setting

Press [D] or [Enter], to select "ECHO"

**BUFFER** returns the received frame with the time interval according to the set time(from 0 to 99999) at "RESPONSE", when receiving one frame.

### 9.3 Frame

**CHAR** returns the received data by a character when receiving one data.  
This is available only when "ASYNC" is selected at Configuration..

**LOOP** loops back the signals of SD-RD, RS-CS, ST1-RT, or what supplied at "LOOP" (ER-DR or ER-CD).  
It loops back in the hardware of analyzer..

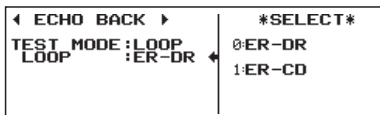

### Action

Press [RUN] to start receiving data and then the analyzer acts according to the setting at "TEST MODE."

- BUFFER** returns the received data per frame according to the Configuration.  
e.g.) "RESPONSE" = 10ms

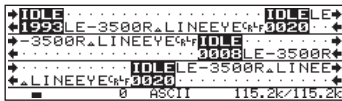

- CHAR** returns the received data with the data bit and Parity/MP bit.  
e.g.) communication speed = 9600bps



It may delay the reception because of the timing of reception.

- LOOP** loops back the signals in the analyzer according to the setting of "INTERFACE."

e.g.)  
When loops back SD-RD; "PORT"=RS-232C, "MODE"=DCE,  
SD(2pin) -> Input IC -> connected in the analyzer -> RC-232C driver in the analyzer -> RD(3pin)

e.g.)  
When loops back SD-RD; "PORT"=RS-530, "MODE"=DTE,  
RD(3,16pin) -> Input IC -> connected in the analyzer -> RC-422/485 driver in the analyzer-> SD(2,14pin)



When the interface is RS-422/485, as it becomes a full-duplex line, set "DRVCTRL" item to "OFF" in the interface settings.

## 4.6 Polling Test(POLLING)

In the Polling test, your analyzer works as slave station or master station. And it tests if data corresponding to each situation is transmitted and received.

### Setting



Move "► ◀" to "POLLING" on the top menu screen ([MENU]).

To select "POLLING," press [E] or [ENTER].

#### ■ Slave Mode

In the slave mode, your analyzer works as slave station. When self-station address is received, response message will be returned.

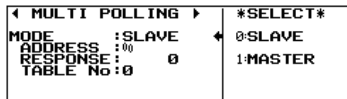

Move "←" to "MODE" item.

And to select "SLAVE," press [0].

#### ◆ Set each condition.

Item	Description	Range of Selection
ADDRESS	Station Address	Within eight characters in HEX
RESPONSE	Delay Time	0 to 99999 1msec. unit
TABLE No	Transmission Table No	0 to F

ADDRESS :Sets station address for your analyzer.

RESPONSE :Sets delay time from reception of a message to transmission of a response message.

TABLE No :Sets the transmission data table number registering response message data.

- ☐ Response message data is required to set to the transmission data table corresponding to the number which is set in "TABLE No:" in advance.

#### <Motion>

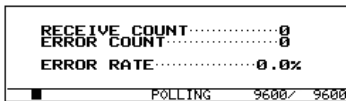

Pressing [RUN] makes RS (CS) and ER (CD) turned on. Also, your analyzer will be in a wait state for reception.

- ① When a message is received, whether or not self-station address is included in received data is detected.
- ② When it is not a message to self-station, reception for next new messages will be ready.
- ③ When it is a message to self-station, reception for that message will be completed. And then, response message will be returned after response time passes.
  - ☐ When a message to self-station is received, error check will be executed (Even if there are errors, only messages being set will be returned as response messages.).

Item	Description of Error Checking
ASYNC	Parity Error, Framing Error, BCC Error
SYNC	Parity Error, BCC Error
HDLC	FCS Error

- ④ Processes No.1 to No.3 will be repeated again.

- ☐ The following is displayed on the result screen: the number of messages transmitting to self-station, the number of error-generated times, and the rate of errors generated.

RECEIVE COUNT	The number of the received messages	0 ~ 99999
ERROR COUNT	The number of the received messages including errors	0 ~ 99999
ERROR RATE	The generating rate of the error messages	0.0 ~ 100%

■ Master Mode

In the master mode, your analyzer works as master station. And it transmits polling message to each station address, and checks data returned from its station address.

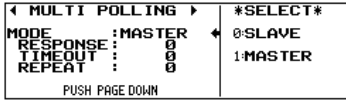

Move “←” to “MODE” item.  
And to select “MASTER,” press .[1]

◆ Set each condition.

Item	Description	Range of Selection	Remark
RESPONSE	Delay time	0 to 99999 1msec. unit	
TIME OUT	Time for timeout	0 to 99999 1msec. unit	(*1)
REPEAT	The number of repeating times	0 to 99999 (times)	(*1)

- RESPONSE :Sets delay time from reception of message from slave station to transmission of next response message.
- TIMEOUT :Sets waiting time for response from slave station.
- REPEAT :Sets the number of times to execute polling test.
- \*1 If 0 is set in the TIME OUT field, time out will not be executed.
- \*2 If 0 is set in the REPEAT field, polling will be continuously executed till the stop key is pressed.

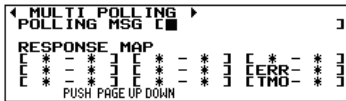

To go to next page, press [PAGE DOWN] .

In this page, the following items are set:

◆ POLLING MSG

Your analyzer (master station) will set polling message to transmit. Up to max. fifteen characters are settable. And slave station address will be added to the position where DON'T CARE “\*” is entered with [END/X]. Slave station address is data, being registered later. In addition, it will be inserted to the “\*” part in order of the minimum station number.

◆ RESPONSE MAP

Both of the following things are set in pairs: response of slave station for polling message and how your analyzer is operated by its response.

[\* - \*] = [A - B]

A : Sets transmission data table No. including response message from slave station.

When DON'T CARE “\*” is set with [END/X], those pairs are ignored without being related to "B" setting.

B : Sets transmission data table No. including message data transmitted by your analyzer when response message from slave station matches A's contents.

[ERR - \*]

When communication errors are generated in response message from slave station, transmission data table No., including message data transmitted by your analyzer, will be set.

[TMO - \*]

When waiting time for response (TIME OUT) from slave station is over, transmission data table No., including message data transmitted by your analyzer, will be set.

◆ In A, data registered in the transmission data table will be used as data compared with response message data received.

In this time, from the first to the twenty third character of registered data will be effectively compared data.

◆ In B, when DON'T CARE “\*” is set in [ERR - \*] and [TMO - \*] with [END/X], polling will be executed to next slave station without transmitting anything.

◆ In B, when a message is transmitted based on the settings of [ERR - \*] and [TMO - \*], your analyzer will be in a wait state for response from the same slave station.

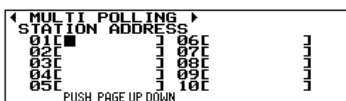

To go to next page, press [PAGE DOWN].

- ◆ Max. 32 kinds of station No. to set slave station address can be registered from 1 to 32.  
(There are four pages to set. And [PAGE UP] and [PAGE DOWN] help you to go to the previous/next page.)
- ◆ Max. eight characters of slave station address are set in each station No. in a HEX input.
- ◆ Slave station address is inserted to polling message in order of the minimum station No. and it is used.
- ◆ When slave station address is unknown/non-registered station No., it will be ignored.

<Motion> ① Pressing [RUN] allows RS and ER of control lines active. And then, polling will be started.  
② It operates corresponding to setting conditions and slave station like below.

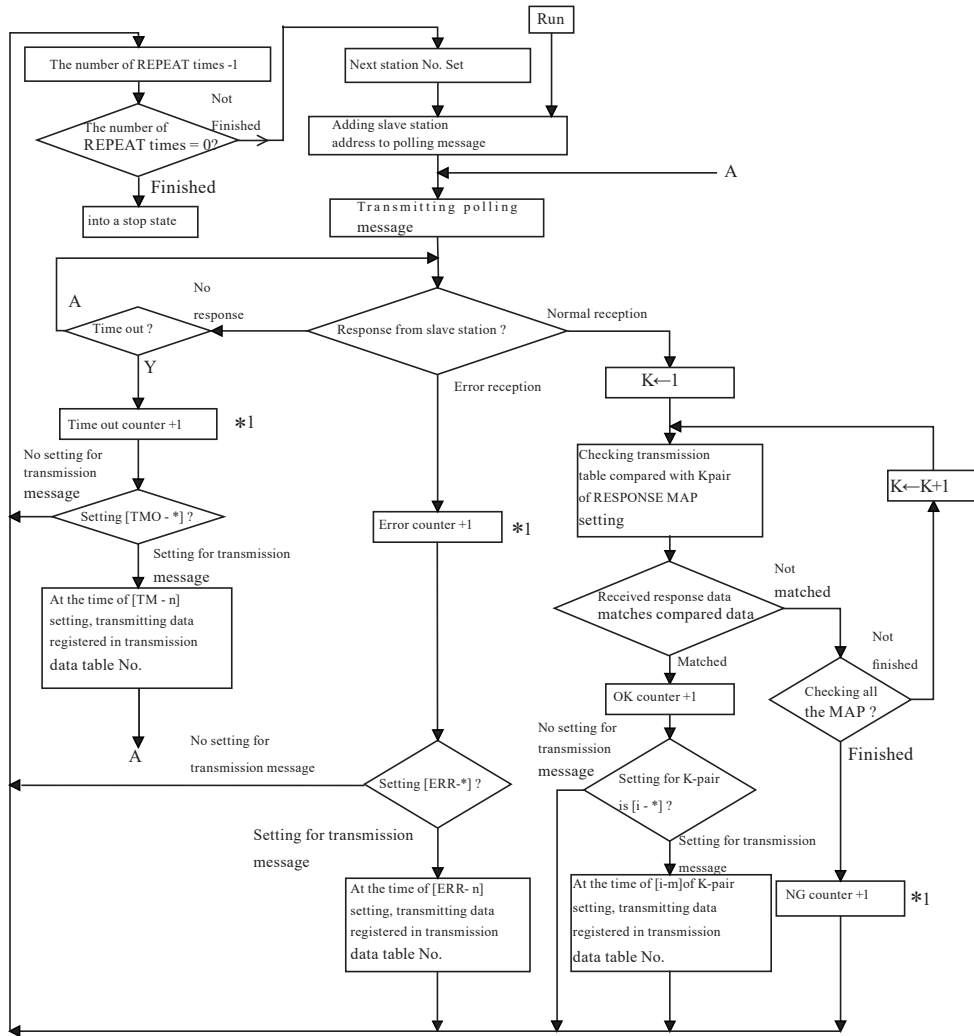

\*1 It indicates count values that are displayed on the measuring result screen for master mode.

SA	OK-MSG	NG-MSG	ERROR	TMOUT
01	00	00	00	00
02	00	00	00	00
03	00	00	00	00
04	00	00	00	00
05	00	00	00	00
06	00	00	00	00
POLLING				9600/ 9600

In order to display the execution results of the master mode, press [DISPLAY MODE].

There are six screens to display the execution result in the master mode. To switch those screens, press [PAGE UP]] or [PAGE DOWN].

- ◆ The measurement screen will display the following count condition every station No. (“SA”).  
OK-MSG: The number of received times for response message from slave station which matches compared data of RESPONSE MAP  
NG-MSG: The number of received times for response message from slave station which does not match compared data of RESPONSE MAP  
ERROR : The number of received times for response message including communication errors  
TMOUT: The number of time out-generated times

◆ When communication errors are generated, the following conditions are checked based on communications protocol.

Item	Description of Error Checking
ASYN	Parity Error, Framing Error, BCC Error
SYN	Parity Error, BCC Error
HDLC	FCS Error



■ Relation with Trigger Function

The following commands are related to the trigger condition being set for “FACTOR” of the trigger function. When those commands are used in a program, set the trigger condition beforehand.

- INT TRG 0: Monitors if the condition set in FACTOR of the trigger No. 0 is satisfied even in the way of execution of the other program. If it is satisfied, it branched to the specified label number.
- WAIT TRG n: Waits until the condition set in the FACTOR of the trigger number n is satisfied.
- IF TRG n : Branches to the specified label number when the condition set in FACTOR of the trigger number n is satisfied.

📖 Enabled/disabled setting for the trigger function and “ACTION” is ignored.

📖 Program Input

■ Setting

Sets the basic communication conditions like protocols and communication speed on the configuration menu screen.



Move “▶ ◀” to “PROGRAM” on the top menu screen ([MENU]).

Set the configuration (communication condition) in advance.

To select “PROGRAM,” press [ENTER] or [F].

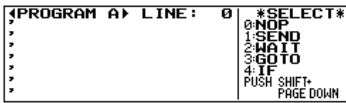

●Composition of Command Language

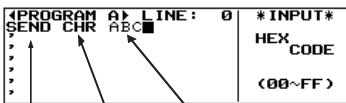

One command language consists of three fields: “Command Field,” “Sub-Command Field,” and “Operand Field.”

Command      Operand  
Sub-Command

<Input Method>

- ① In order to display the program entry screen, press [F] on the top menu. The command field of all line’s numbers are filled with “ ” (NOP command = invalid command) initially.
- ② Selection of Program  
Up to four programs can be made. Press [SHIFT] + one key from [A] to [D] to select them. Then, the selected program will be displayed on the upper part of the screen.
- ③ Programming  
The blinking cursor indicates the line to input a program. (Input programs from line: 0.)

◆ Command Field

Press the numerical keys to select a desired command from the items of “SELECT.”  
Press [SHIFT] + [PAGE DOWN], [SHIFT] + [PAGE UP] to change the display of “SELECT.”

◆ Sub-Command Field

After the command is entered, the cursor moves to the sub-command entry field. The sub-commands will be displayed in “SELECT.” Press the numerical keys to select a desired sub-command from the displayed items.

◆ Operand Field

After the sub-command is entered, the cursor moves to the operand entry field. The operands will be displayed in “SELECT.” Press the numerical keys to select a desired operand from the displayed items or enter the number of the character string. After entering all of required portion in each command, the cursor moves to the command field of the next line automatically.

◆ Moving of the Line Cursor

- Jump to the first line: Press [SHIFT]+[TOP/DEL]
- Jump to the final line: Press [SHIFT]+[END/X]
- Jump to a desired line number :Press [SHIFT]+[▲] “ ←” will be displayed at line number displayed portion. Enter the destination line number by pressing the numerical keys and press [Enter].

## <Modifying a Program>

### ◆ Modification of Command

- ① Deleting Lines: Move a cursor to the command field. And press [TOP/DEL] to delete the command in the line numbers. The commands in the following lines are advanced.
- ② Inserting Lines: Press the numerical key of the left side to select a desired command at displayed contents in “SELECT.” When the corrected command is entered, the following line numbers are moved down.

📄 Entry operation causes the command in the last line (line No.511) to be deleted.

### ◆ Modification of a Sub-Command and an Operand

Move the cursor to the sub-command field. And then, enter a new sub-command. Old data will be overwritten. Modification of an operand is the same.

### ◆ Moving a Line

PROGRAM A LINE: 100	*INPUT*
SEND TBL01	SET LINE
,	NO
,	& ENTER
,	(0~511)
,	FALL DEL

Press [SHIFT]+[▲]. Press the number key corresponding to the line to be moved. Press [ENTER]. Then, the cursor will jump there.

### ◆ Deleting an Entire Program

PROGRAM A LINE: 0	*SELECT*
SEND TBL01	ENTER:
,	ALL
,	DELETE
,	STOP:
,	CANCEL

Press [SHIFT]+[▲].

Press [F].

Press [ENTER]. The entire program will be deleted.

📄 Once the entire program is deleted, you can never undo it again.

## <Notice on Programming>

The commands have the following differences in timing and the effect of the execution.

### ◆ Data Transmission and Next Command

When the SEND command (the data transmission command) is executed, the program control proceeds to execute the next command before the data transmission is completed. Therefore, when the response to transmission data is stored in the frame buffer by means of the WAIT FRM command (one frame receive waiting command) or the like, the WAIT FRM command is placed next to the SEND command.

ex.)

SEND TBL 00

WAIT FRM CLR

In the case of the following commands that can be executed only after the data transmission is completed, they will not be executed because of a program wait state till data transmission is completed: the new SEND, the SET LN, the STOP command, etc.

### ◆ Interruption during a Wait State

Your analyzer is in a wait state because of the execution of the WAIT command (the program execution waiting command). Also, the trigger condition is satisfied and the program control is branched by the INT (the trigger interrupt command). In this situation, when “Don't Care” is set for the destination of the return by RETI (the trigger interrupting and returning command), the command set after the WAIT command will be executed. Therefore, when the program control is branched in a wait state by the WAIT FRM command, the command will not be executed. In addition, the frame buffer may be emptied.

### ◆ Setting of Several INT Commands

When several INT commands (the trigger interrupt command) are placed in a program with different branching destinations, the program control branches to last INT command executed before the trigger conditions are satisfied.

### ◆ Setting “LINE” for the Trigger Condition of the INT Command

If the INT command (the trigger interrupt command) is used with “LINE” being set for the trigger condition, the program control branches to the specified destination when the combination of logical values of control lines changes from disagreement to agreement after the INT command is executed. Therefore, if agreement is already obtained when the INT command is executed, the program control is not branched until the agreement is lost and then obtained again.

### <Saving a Program>

The prepared program is saved in the backup memory even if the power is turned off.

If you have made more than one program and want to save them, use a SD card (option) or aUSB flash in the file mode and save them as files named “xxxxx.SU.”

Four programs (A to D) are loaded or saved collectively. Especially, when they are loaded, all the programs will be overwritten.

### <Printing a Program List>

◆ In order to print the entire program list from line No. 0 to No.511 Press [Print] on the program entry screen.

If there are more than three consecutive NOP commands, only the first three lines are printed. The fourth and the following NOP commands are neglected to save papers.

◆ In order to print a part of a program displayed on the screen

Press [SHIFT]+[PRINT].

## Starting and Ending a Simulation

### <Start>

#### ■ Selecting a Kind of Running Program



Move “▶ ◀” to “PROGRAM” on the top menu screen ([MENU]).

Set the configuration (Communication Condition Setting) in advance.

2.6 Communication Condition Setting

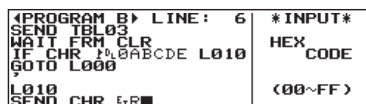

① In order to go to the program entry screen, press [F] or [Enter].

② Select the one, which you wish to execute, out of four programs with [SHIFT]+[A] to [D].

③ Press [RUN].

Program commands are executed sequentially starting with line No. 000. And then, the line number of the command currently executed is displayed on the bottom right section of the screen.

In order to check the current value of timer/counter and register, press [TIME/COUNT].

If [RUN] is pressed without selecting any programs, a program simulation or an entered program, which is operated before, will be selected.

When the execution reaches last line (line No. 511), it will stop at the moment.

The length of the interval between the executions of two commands varies depending on the amount of data transmitted/received in the period and communication speed.

### <End>

Press [STOP].

A running program will stop. Also, when the STOP command is executed, it will stop.



**Commands**

No	Command	Operation
0	NOP	No Operation
1	SEND CHR □□□□□□□□	Data communications up to 8 characters.
	SEND TBL □□	Data communications of the specified transmission data table.
	SEND REG □ GRP □	Data communications of the transmission data table specified by a register value.
	SEND BUF	Transmits data in the frame buffer.
	SEND KEY GRP □	Transmits data in the transmission data table corresponding to keystroke.
	SEND DA □□ +REG □	Transmits data of the data array specified by additional value of preset value of the data array number and the value specified by register number.
	SEND BRK	Transmits a break. (ASYNC mode only)
2	WAIT CHR □□□□□□□□	Waits for the particular character string of up to 8 characters to be received.
	WAIT FRM (CLR/NOCLR)	Waits for a frame to be received.
	WAIT TRG □	Waits for a specified trigger condition to be specified.
	WAIT TM □□□□	Waits for a specified period of time.
	WAIT KEY	Waits until one of the keys from [0] to [F] is pressed.
	WAIT LN □ = □	Waits until the logical values of the control lines meet with the setting.
3	GOTO L □□□	Jumps to a specified label number.
4	IF CHR □□□□□□□□ L □□□	Branches to a specified label number if the particular character string is included in the frame buffer.
	IF TRG □ L □□□	Branches to a specified label number if the trigger conditions are satisfied.
	IF TM □ L □□□	Branches to a specified label number if the timer exceeds the setting value.
	IF CT □ L □□□	Branches to a specified label number if the counter exceeds the setting value.
	IF LN □ = □ L □□□	Branches to a specified label number if the logic values of control lines meet with the setting.
	IF REG □ □ REG □ L □□□	Branches to a specified label number if the inequality relation between registers is satisfied.
	IF TBL □□ L □□□	Branches to a specified label number if it is satisfied with data of table specified by the table number.
	IF DA □□ +REG □ L □□□	Branches to a specified label number if the specified value of a data array number is same as the sum of the value of data array specified in the register number.
5	CALL L □□□	Jumps to a subroutine marked with a specified label number.
6	RET	Returns from the subroutine.
7	SET REG □ □□□□□□□	Sets a value to register, or increments or decrements the register.
	SET LN □ = □	Sets a value of the control line.
	SET TM □ □□□□□□□	Sets a value to the timer, or controls the start, the stop or the restart of the program.
	SET CT □ □□□□□□□	Sets a value to the counter, or increments or resets the counter.
	SET BZ	Sets the buzzer.
	SET OUT	Outputs a pulse to the trigger out terminal.
	SET DA □□ □□□□□□□□	Sets data to the data array.
	SET DV □□ REG □ □	Sets the specified number of characters on contents in register as a character string to the data array.
8	INT TRG 0 L □□□	Jumps to the subroutine marked by the specified label number when the condition of trigger 0 is satisfied.
9	RETI L □□□	Returns from subroutine started by the INT command.
A	DISI TRG 0	Disables an interruption.
B	STOP	Stops the running of simulation operation.
C	L □□□	Enters a label number in a range from 0 to 999 in decimal notation.

## 4.8 Explanation for Each Command

### NOP Command (Invalid Command)

The NOP command, which is displayed as “;” is the command that has no impact on the program execution.

NOP

<Entering>

Cursor Position	Enter & Operation
Command Field	0
Sub-Command Field	-
Operand Field	-

<Operation>

- When the program is running, the NOP command is ignored and the instruction of the next line number is executed.

### SEND Command (Data Transmission Command)

The SEND command is used to transmit data from your analyzer.

1)SEND CHR  (Character Line Transmission Command)

<Entering>

Cursor Position	Enter & Operation
Command Field	1
Sub-Command Field	0
Operand Field	Enter a string of up to 8 characters in hexadecimal code. To enter a string of less than 8 characters, finish the entry by pressing [▼] and proceed to the next line.

<Operation>

- The character string which is set in the operand field is transmitted. Use this command to transmit a short character string such as the communication control character.
- Data is transmitted as follows, depending on SYNC MODE.

SYNC MODE	Contents of Data Transmission
ASYN	If the character string for transmission includes BCC calculation start and stop characters, the BCC code is inserted and transmitted automatically.
SYNC • BSC	The SYNC character and the RST character are automatically inserted to data and transmitted. In addition, if the character string for transmission includes BCC calculation start and stop characters, the BCC code is added automatically.
HDLC	The flag and the FCS code are automatically inserted to data, and are transmitted.
PPP	If transmission data forms a frame, the FCS code is automatically inserted and transmitted.

2)SEND TBL  (Data Table Transmission Command)

<Entering>

Cursor Position	Enter & Operation
Command Field	1
Sub-Command Field	1
Operand Field	Enter a data table number in the scope of 00 to 9F.

<Operation>

- Data, which is in the transmission data table on the number being set in the operand field, is transmitted. Use this command to send multi character strings.

3)SEND REG  GRP  (Register-Specified Data Table Transmission Command)

<Entering>

Cursor Position	Enter & Operation
Command Field	1
Sub-Command Field	2
Operand Field	Enter a register number with [0] to [F] keys and a table group number with [0] to [9] keys. By * (Don't care), all the groups will be the target.

<Operation>

- It specifies a transmission data table number from the scope of 0 to F by the register value, which targets the table group numbers of 0 to 9 which set in the operand field. And it transmits the data of the transmission data table.

- When the register value is over 16, the transmission data table, with the remainder divided by 16, is specified. And if data without setting any data table is specified, any data is not transmitted. Then, the next instruction will be executed.
- When set "\*" to a table groupe, it directly selects depending on the register value (0 to 159). In this case, when register value is 160 or more, the remainder of the value divided by 160 will be applied.

#### 4) SEND BUF (Frame Buffer Data Transmission Command)

<Entering>

Cursor Position	Enter & Operation
Command Field	1
Sub-Command Field	3
Operand Field	-

<Operation>

- Data stored in the frame buffer is transmitted.
- If no data is stored in the frame buffer, the next instruction is executed without sending any data.  
Before it is executed, the WAIT FRM command is required to execute in order to store data in the frame buffer.
- ▣ Parity error, framing error, break and abort error cannot be transmitted.

#### 5) SEND KEY GRP □ (Key-Specified Data Table Transmission Command)

<Entering>

Cursor Position	Enter & Operation
Command Field	1
Sub-Command Field	4
Operand Field	Enter a table group number by 0 to 9 keys.

<Operation>

It waits until you press a key ([0] to [F]) and when you press the key it transmits the data of the transmission data table of the table group specified in the operand field. (The data to be transmitted corresponds with the key number you press.)  
When you specify a data table at which no data is set, it does not transmit data. Then it executes the next instruction.

#### 6) SEND DA □□ +REG \* (Data Array Transmission Command)

<Entering>

Cursor Position	Enter & Operation
Command Field	1
Sub-Command Field	5
Operand Field	Enter two digits of a data array number with the key, 0 to 9.
	Enter a register number with the key, [0] to [F]. Offset cannot be set by "*" (don't care).

<Operation>

- The Data array is set for the data array number in the operand field. And register value, which is set for the register number, is added as an offset value to that data array. After that, that value is as a data array number. And corresponding data of data array will be transmitted. If the result of the addition includes three digits, its last two digits are as data array numbers and corresponding data of data array is transmitted.
- When "\*" is set for a register number, data of the data array specified by the data array number is transmitted.  
If the "SEND DA xx" command is entered continuously, data registered in the data array is connected and transmitted. In this case, the size of transmission data is up to 1Kbytes. When it exceeds 1Kbytes, the excess of data will be omitted.
- If no data is registered in the data array set to the data array number, any data is not transmitted. And the next command is executed.
- Transmission data depends on the selection which is made on the configuration menu as the "SEND CHR" command.

```

PROGRAM A LINE: 3 *SELECT*
SET DA 33 ABC      0NOP
SET REG4 000010    1SEND
SEND DA 23+REG4    2WAIT
                  3GOTO
                  4IF
                  PUSH SHIFT+
                  PAGE DOWN

```

e.g.) Transmitting the contents (ABC) of DA33

- ① Set ABC to DA33.
- ② Set 10 to REG4
- ③ DA number is REG4 value plus 23 (=33).  
Transmit data ABC of DA number.

```

PROGRAM A LINE: 6 *SELECT*
SET DA 00 ABC      0NOP
SET DA 01 DEF      1SEND
SET DA 02 GHI      2WAIT
SEND DA 00+REG*    3GOTO
SEND DA 01+REG*    4IF
SEND DA 02+REG*    PUSH SHIFT+
                  PAGE DOWN

```

e.g.) Connecting data from DA00 to DA02 and transmitting it (ABCDEFGHI)

- ① Set ABC to DA00.
- ② Set DEF to DA01.
- ③ Set GHI to DA02.
- ④ The "SEND DA" command is entered continuously.  
Data registered in the DA numbers from 00 to 02 are connected. And it (ABCDEFGHI) is transmitted.

7)SEND BRK (Break Transmission Command)

<Entering>

Cursor Position	Enter & Operation
Command Field	1
Sub-Command Field	6
Operand Field	-

<Operation>

Transmits a break. (ASYNCR mode only)

 WAIT Command (Command to Halt Program Execution)

The WAIT command is used to halt the execution of a program until the particular conditions are satisfied.

 If the "INT TRG" command interrupts this command, a wait state is canceled.

1)WAIT CHR  (Command to Wait for Character Reception)

<Entering>

Cursor Position	Enter & Operation
Command Field	2
Sub-Command Field	0
Operand Field	Enter a string of up to 8 characters in hexadecimal code. To enter the string of less than 8 characters, finish the entry by pressing ▼ and proceed to the next line. Additionally, "Don't Care" (*) and a flag ( [SHIFT] + [F] ) are acceptable.

<Operation>

- Your analyzer halts the program control until the specific character string, which is previously set in the operand field, is received.
- When "Don't Care" is set, your analyzer halts the program control until some character is received (This command does not use frame buffer.).

2)WAIT FRM CLR

WAIT FRM NOCLR (Command to Wait for Reception of a Frame)

<Entering>

Cursor Position	Enter & Operation
Command Field	2
Sub-Command Field	1
Operand Field	Select CLR/NOCLR with the key [0] or [1].

<Operation>

- Your analyzer halts the program control until one frame of data is received.
- This command stores received data in frame buffer. And the IF command allows you to check it in frame buffer.
- Data stored in the frame buffer remains unchanged until this command is executed again.

3)WAIT TRG  (Command to Wait for Satisfaction of Trigger Conditions)

<Entering>

Cursor Position	Enter & Operation
Command Field	2
Sub-Command Field	2
Operand Field	Enter a trigger number with the key, 1 to 3 (Trigger 0 is not selectable).

<Operation>

- Your analyzer halts the program control until the condition, which is set for the trigger FACTOR specified in the operand field, is satisfied.
- Valid and invalid conditions for the specified trigger and the contents being set for ACTION are all ignored.
  -  WAIT TRG detects the turning point from unsatisfied to satisfied condition. When it branches by "INT TRG command," monitoring a trigger is not executed.

4)WAIT TM  (Command to Wait for Designated Time)

<Entering>

Cursor Position	Enter & Operation
Command Field	2
Sub-Command Field	3
Operand Field	Enter waiting time in four digits decimal figures with the key, 0 to 9.

<Operation>

- Your analyzer halts the program control for setting time specified in the operand field in the unit of 1msec.

5) WAIT KEY (Command to Wait for Key Stroke)

<Entering>

Cursor Position	Enter & Operation
Command Field	2
Sub-Command Field	4
Operand Field	-

<Operation>

- Your analyzer halts the program control until one of the numerical keys from [0] to [F] is pressed. Whatever key is pressed down, the result is the same.

6) WAIT LN □ = □ (Command to Wait for Meeting Control Line)

<Entering>

Cursor Position	Enter & Operation
Command Field	2
Sub-Command Field	5
Operand Field	Enter the control line with the key, [0] to [7].
	Enter the logic value with the key [0] or [1].

<Operation>

- Program control waits until the logic values of the control lines meet with the setting.



GOTO Command (Designated Label Number Branch Command)

The GOTO command branches the program control unconditionally to designated label number.

GOTO L □□□

<Entering>

Cursor Position	Enter & Operation
Command Field	3
Sub-Command Field	-
Operand Field	Enter a label number in three digits decimal figures with the key, [0] to [9].

<Operation>

- The program control branches to the instruction marked with the label number specified in the operand field.



IF Command (Conditional Comparison Branch Control)

The IF command branches the program control to the designated label number if the particular conditions are satisfied. Or, it processes the next instruction if they are not satisfied.

1) IF CHR □□□□□□□□ L □□□ (Received Character Comparison Command)

<Entering>

Cursor Position	Enter & Operation
Command Field	4
Sub-Command Field	0
Operand Field	Enter a character string of up to 8 characters in hexadecimal code. To enter a string of less than 8 characters, finish the entry by pressing ▼ and move a cursor to the label entry section. Additionally, "Don't Care" (*) and a flag ([SHIFT] + [F]) are acceptable.
	Enter a label number in three digits decimal figures with the key, 0 to 9.

<Operation>

- Data in the frame buffer is searched. And if the character string specified in the operand field is found, the program command branches to the designated label number line.

2)IF TRG □ L □□□ (Judgment Command to Check Satisfaction of Trigger Conditions)

<Entering>

Cursor Position	Enter & Operation
Command Field	4
Sub-Command Field	1
Operand Field	Enter a trigger number with the key, [1] to [3] (Trigger 0 is not selectable).
	Enter a label number in three digits decimal figures with the key, [0] to [9].

<Operation>

- The program control branches to the designated number if the conditions for the FACTOR of the trigger specified in the operand field are satisfied.
- The program control branches depending on the setting of the trigger event as follows.

FACTOR	Judgment Contents
TM/CT	Does not perform anything. The next command is executed unconditionally.
CHARACTER,ERROR	Data in the frame buffer is checked to see if the conditions are satisfied.
LINE	The conditions are checked to see if it is satisfied when the command is executed.
EXTERNAL	Program control branches if an external trigger input has been received before the command is executed.
IDLE TIME	The conditions are checked to see if it is the condition value or over when the command is executed.

- ☞ Once the command is executed, the previous external trigger input is reset.
- ☞ ON/OFF of trigger and setting of "ACTION" will be ignored.

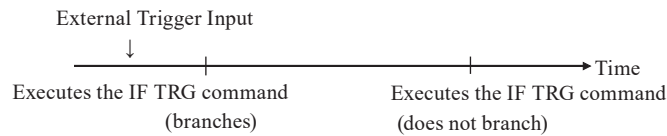

3)IF TM □ L □□□ (Judgment Command on Timer)

<Entering>

Cursor Position	Enter & Operation
Command Field	4
Sub-Command Field	2
Operand Field	Enter a timer number with the key [0] or [1].
	Enter a label number in three digit decimal figures with the key, [0] to [9].

<Operation>

- The program control branches to the designated label number if the measurement value of the timer specified in the operand field is over the preset value.

4)IF CT □ L □□□ (Judgment Command on Counter)

<Entering>

Cursor Position	Enter & Operation
Command Field	4
Sub-Command Field	3
Operand Field	Enter a counter number with the key [0] or [1].
	Enter a label number in three digit decimal figures with the key, [0] to [9].

<Operation>

- The program control branches to the designated label number if the measurement value of the counter specified in the operand field is over the preset value.

5)IF LN □ = □ L □□□ (Judgment Command on Control Line)

<Entering>

Cursor Position	Enter & Operation
Command Field	4
Sub-Command Field	4
Operand Field	Enter a control line with the key, [0] to [7].
	Enter the logic with the key [0] or [1].
	Enter a label number in three digit decimal figures with the key, [0] to [9].

<Operation>

- The program control branches to the designated label number if the logic of the control lines specified in the operand field meets with the setting.

6)IF REG □ □ REG □ L □ □ □ (Judgment Command on Register Value)

<Entering>

Cursor Position	Enter & Operation
Command Field	4
Sub-Command Field	5
Operand Field	Enter a register number with the key, [0] to [F].
	Enter all size of relation with the key, [0] to [5].
	Enter the label number in three digits decimal figures with the key, [0] to [9].

<Operation>

- The program control branches to the designated label number if all the size of the relationship between the registers specified in the operand field is satisfied.
  - ▣ If you want to compare the contents of a register with a constant value, execute this command after storing the constant value in another register by using the SET command.

7)IF TBL □ □ L □ □ □ (Judgment Command on Data Table Comparison)

<Entering>

Cursor Position	Enter & Operation
Command Field	4
Sub-Command Field	6
Operand Field	Enter a data table number in the scope of 00 to 9F.
	Enter a label number in three digits decimal figures with the key, [0] to [9].

<Operation>

- The program control branches to the designated label number if data satisfied up to 23 characters from the top of data, which is registered in the data table of the data table group specified in the operand field, is detected in the frame buffer.
- Parity bit is not a object to be compared.

8)IF DA □ □ +REG □ L □ □ □ (Judgment Command on Data Array Comparison)

<Entering>

Cursor Position	Enter & Operation
Command Field	4
Sub-Command Field	7
Operand Field	Enter a data array number with the key, [0] to [F]. [* (Don't Care) allows the offset to be invalid.]
	Enter a label number in three digits decimal figures with the key, [0] to [9].

<Operation>

- The program control branches to the designated label number if data, satisfied with data being set in the specified data array in the operand field, is detected in the frame buffer.
- The method of designating a data array number is the same as that of "SEND DA Command."



## CALL Command (Subroutine Call Command)

The CALL command is used to call a subroutine.

CALL L □ □ □

<Entering>

Cursor Position	Enter & Operation
Command Field	5
Sub-Command Field	-
Operand Field	Enter a label number in three digits decimal figures with the key, [0] to [9].

<Operation>

- The program control branches to the subroutine that is marked with the label number specified in the operand field. The subroutine can be nested up to 100 folds.



## RET Command (Command to Return from Subroutine)

The RET command is used to return from the subroutine to the main routine.

RET

<Entering>

Cursor Position	Enter & Operation
Command Field	6
Sub-Command Field	-
Operand Field	-

<Operation>

- The program control returns from the subroutine to the main routine. This command must be set to the end of the subroutine.

## SET Command (Device Setting Command)

The SET command is used to control timers, counters, and registers and to preset values for them. Also, it is used to preset the logical values of the control lines, and to control the buzzer and external trigger output.

### 1) SET REG $\square \square \square \square \square \square$ (Register Preset Command)

<Entering>

Cursor Position	Enter & Operation
Command Field	7
Sub-Command Field	0
Operand Field	Enter a register number with the key, [0] to [F].
	Enter a preset value of the register in six digits decimal figures with the key, [0] to [9]. Or, Specify either increment or decrement with the key A or B.

<Operation>

- The content of the register specified in the operand field is changed.

Register Preset Value	Setting Condition
Six Digits Decimal Figures	The preset value is entered in the register.
A	1 is added to the register contents "INC".
B	1 is subtracted from the register contents "DEC".

- When the program starts, all the registers will be set 000.

### 2) SET LN $\square = \square$ (Control Line Logic Setting Command)







<Entering>

Cursor Position	Enter & Operation
Command Field	7
Sub-Command Field	1
Operand Field	Enter a control line with the key, [0] to [6].
	Enter the logic with the key [0] or [1].

<Operation>

- The control line specified in the operand field is set to the specified state.
- The relation between the control line and the values set in the operand field is as follows.

Value	Control Line	Value	Control Line
0	RS	3	CD
1	CS	4	ER
2	DR	6	CI

-  The control line is set to mark state ("0") when the program starts.
-  The settable control line is subject to the condition of DTE/DCE of your analyzer.
-  When the control of the control line is ON, the condition of each line is changed without being related to this command: RS, ER, CS and CD.
-  Set line control "OFF" for normal use.
-  Although the setting item, "5:SQ," is displayed because of compatibility in the operand field with old models, it cannot be controlled.
-  CI operates in the V.35 mode only.

### 3) SET TM $\square \square \square \square \square \square$ (Timer Control Command)

<Entering>

Cursor Position	Enter & Operation
Command Field	7
Sub-Command Field	2
Operand Field	Enter a timer number with the key, [0] or [1].
	Enter a preset value of the timer in six digits decimal figures with the key, 0 to 9. Or, specify start, stop, and restart with the key, A to C.

<Operation>

- The preset value, which is compared with measurement value, is set to the timer specified in the operand field. Moreover, the timer operation is controlled.

Preset Timer Value	Setting Condition
Six Digits Decimal Figures	Set a preset value.
A	Starts the timer (START).
B	Stops the timer (STOP).
C	Restarts the timer [clear to 0 and start] (RESTART).

- The preset timer value and the initial value will be the preset condition on the timer/counter setting screen of the top menu.



4)SET CT □ □ □ □ □ □ □ □ (Counter Control Command)

<Entering>

Cursor Position	Enter & Operation
Command Field	7
Sub-Command Field	3
Operand Field	Enter a counter number with the key, 0 or 1.
	Enter a preset value of the counter in six digits decimal figures with the key, 0 to 9. Or, specify increment or reset with the key( A, B) .

<Operation>

- The preset value, which is compared with measurement value, is set to the counter specified in the operand field. Moreover, the counter operation is controlled.

Register Counter Value	Setting Condition
Six Digits Decimal Figures	Sets the preset counter value.
A	Adds 1 to the counter (INC).
B	Clears the counter (RESET).

- The preset counter value and the initial value will be the preset condition on the timer/counter setting screen of the top menu.

5)SET BZ(Buzzer Control Command)

<Entering>

Cursor Position	Enter & Operation
Command Field	7
Sub-Command Field	4
Operand Field	-

<Operation>

- Buzzer sounds.
  - ☐ If you select OFF for the “BUZZER” setting from the OTHER FUNCTION of the condition menu, even if this command is executed, the buzzer does not sound.

6)SET OUT (Trigger Out Output Command)

<Entering>

Cursor Position	Enter & Operation
Command Field	7
Sub-Command Field	5
Operand Field	-

<Operation>

- The output pulse is delivered to the trigger out terminals (L level output for about 1mS).
  - ☐ Even if this command is executed again during outputting the pulse, the pulse (H ->L) will not be output.

7)SET DA □ □ □ □ □ □ □ □ □ □ (Data Array Setting Command)

<Entering>

Cursor Position	Enter & Operation
Command Field	7
Sub-Command Field	6
Operand Field	Enter a data array number with the key, 0 to 9.
	Enter a string of up to eight characters in hexadecimal code. To enter a string of less than eight characters, finish the entry by pressing ▼ and proceed to the next line.

<Operation>

- The specified character strings are set to the data array of the designated number.

8)SET DV  REG  (Data Array Setting Command)

<Entering>

Cursor Position	Enter & Operation
Command Field	7
Sub-Command Field	7
Operand Field	Enter a data array number with the key, 0 to 9.
	Enter the digit number of a character with the key, 0 to 6.

<Operation>

- The content of the specified register is set as a character string to the data array for the digit number of the specified character.

```

4PROGRAM A1 LINE: 2 *INPUT*
SET REG0 00012
SET DV 00 REG0 5 SET REGISTER NO
SEND DA 00+REG* <0-F>
, OF *
,
,

```

e.g.) Transmitting REG0 value 12 as a character string of five digits

- Set 12 to REG0.
- Change 12 into a character string of five digits. And set it to DA00.
- Transmit DA00 (00012).

 INT Command (Trigger Interrupt Command)

The INT command monitors whether or not the conditions of trigger 0 are satisfied while the program is running. And when the conditions are satisfied, the program control branches to the designated label number.

INT TRG0 L

<Entering>

Cursor Position	Enter & Operation
Command Field	8
Sub-Command Field	-
Operand Field	Enter a label number in three digits decimal figures with the key, 0 to 9.

<Operation>

- On executing this command, the conditions of trigger 0 are monitored to check if they are satisfied while the program is running. When the conditions are satisfied, the command during operating is completed. Then, the program control branches to the designated label number specified in the operand field. However, if your analyzer has been in a wait state by the WAIT command, this state will be cancelled by the INT command. Moreover, the WAIT command branches as an inoperative command during operating.
- Trigger conditions are not monitored while the destination subroutine of the branches is being executed. Monitoring is resumed when the RETI command returns the program control from the subroutine to the main routine.

 The following two things are all ignored. One is the valid and invalid condition for the specified trigger. The other is the content being set for ACTION.

 RETI Command (Trigger Interrupt Reset Command)

The RETI command returns the program control to the main routine from a subroutine which the program control is branched to by the INT command.

RETI L

<Entering>

Cursor Position	Enter & Operation
Command Field	9
Sub-Command Field	-
Operand Field	Enter a label number in three digits decimal figures with the key, 0 to 9. Or, enter "don't care" (*) by X key.

<Operation>

- The program control returns to the main routine from a subroutine which the program control is branched to by the INT command. If the label number of three digits decimal figures is entered in the operand field, the main routine is restarted at the instruction marked with the label number. If "Don't Care" is entered in the operand field, the main routine is restarted at the instruction next to that which is being executed before branching by the INT command.

 DISI Command (Trigger Interrupt Disable Command)

The DISI command disables branching when trigger conditions are satisfied after executing the INT command.

DISI TRG0

<Entering>

Cursor Position	Enter & Operation
Command Field	A
Sub-Command Field	-
Operand Field	-

<Operation>

- The branch of programs on satisfaction of trigger conditions is disabled.
- To enable branching, execute the INT command again.

## STOP Command (Program Quitting Command)

The STOP command stops a running program.

STOP

<Entering>

Cursor Position	Enter & Operation
Command Field	0
Sub-Command Field	-
Operand Field	-

<Operation>

- The program simulating operation is stopped. And then, your analyzer will be in an off-line state.

## LBL Command (Command to Define Label)

The LBL command defines the destination of a branch command.

L

<Entering>

Cursor Position	Enter & Operation
Command Field	C
Sub-Command Field	-
Operand Field	Enter a label number in three digits decimal figures with the key, 0 to 9.

<Operation>

- The LBL command defines a branch destination of the following commands: GOTO, IF, CALL, INT and RETI.
- The LBL command has no effect on the operation as the NOP command.

### ■ Sample Program

Transmits data table 0. If other than "06" is received, it is transmitted again. If an error is received, data in the data table 1 is transmitted. And then, the program will stop. On the other hand, if no response is received within three seconds, data in the data table 2 is transmitted. After that, the program will stop.

```

SET TM0 003000    .....    Sets three seconds to timeout.
INT TRG0 L004    .....    Executes the INT command (Monitoring timeout)
,
L001
SET TM0 RSTART    .....    Restarts timer 0.
SEND TBL00        .....    Transmits data in the data table 00.
WAIT FRM CLR      .....    Waits for receiving a signal of one frame.
SET TM0 STOP      .....    Stops timer 0.
IF TRG1 L003      .....    Judges errors.
IF CHR AK L002    .....    Judges AK characters.
GOTO L001          .....    Branches to retransmission process.
,
L002
STOP              .....    Stops the program.
,
L003
SEND TBL01        .....    Transmits data in the data table 01.
GOTO L002         .....    Ends the program to branch.
,
L004
SEND TBL02        .....    Transmits data in the data table 02.
RETI L002         .....    Branches to the end of the program.

```

```

Setting of Trigger 0    FACTOR :TM/CT
                        POINT  :TM0
Setting of Trigger 1    FACTOR :ERROR

```

# Chapter 5 Bit Error Rate Test (BERT) Function

The analyzer has the ability to send the test pattern and to compare the received data to the test pattern. This makes it possible to evaluate quality of a data communication line, including modems, and to locate the point of trouble in the data communication line by means of loop-back test or interactive test.

When "PROTOCOL" is set to "ASYNC" or "SYNC" the function cannot be performed.

## Cable Connection

### Connection for loop-back test

In the loop-back test, the test pattern data sent from the analyzer is sent back at each node of the communication channel. This enables an evaluation of the round-trip path over the communication channel via the node (loop-back point), and locates a trouble point by testing while changing the loop-back point.

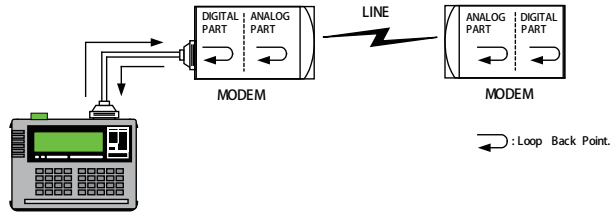

The loop-back point can be usually set and changed in a modem by using the self-test function of the normal modem. (Consult the instruction manual of the modem you use.)

### Connection for interactive test

In an interactive test, the communication channel is tested by connecting the analyzer to a device which has the BERT function equivalent to that of the analyzer, and the same test patterns are sent from both sides. This allows testing of the send and the receive lines independently.

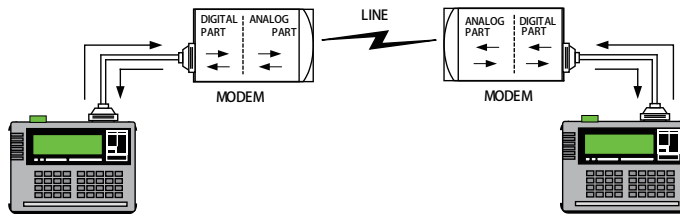

## Setting

MONITOR ONLINE DELAY TREND	SIMULATE MANUAL BUFFER FLOW ECHO POLLING PROGRAM	SETUP 0:CONFIG 1:INTERFACE 3:CONDITION 4:HAVE MON 5:BERT
BERT ▶ BERT ◀		

Move "▶ ◀" to "BERT" on the top menu screen ([MENU]).

Set the configuration (communication conditions) in advance.

◀ BERT ▶	*SELECT*
TEST MODE : CONTINUE ◀	0:CONTINUE
PATTERN : 63	1:R-BIT
FLOWCTRL : OFF	2:RUN TIME
	3:REPEAT

### 2.6 Communication Condition Setting

To select "BERT," press [8] or [ENTER].

1. Set according to the table below.

Item	Meaning	Setting range
TEST MODE	Test mode	CONTINUE/R-BIT/RUNTIME/REPEAT
PATTERN	Test pattern	63/511/2047/MARK/SPACE/ALT/DBL-ALT/1IN4/1IN8/1IN16/3IN24
FLOWCTRL	RTS/CTS Flow control	ON/OFF

2. Place "◀" mark on "TEST MODE" to select the kind of the test mode.

Setting	Name	Description
0	CONTINUE	Continuous measurement
1	R-BIT	Continues the test until the number of effective received bits exceeds the designated value.
2	RUN TIME	Continues the test until the measurement time exceeds the designated value. (The lapse of time after synchronization has been established.)
3	REPEAT	Measures BERT measurement of the specific time repeatedly.

◀ BERT ▶	*SELECT*
TEST MODE: R-BIT	0: CONTINUE
COUNT : 1.0E3	1: R-BIT
PATTERN : 63	2: RUN TIME
FLOWCTRL : OFF	3: REPEAT

◀ BERT ▶	*SELECT*
TEST MODE: RUN TIME	0: CONTINUE
SEC : 60	1: R-BIT
PATTERN : 63	2: RUN TIME
FLOWCTRL : OFF	3: REPEAT

◀ BERT ▶	*SELECT*
TEST MODE: REPEAT	0: CONTINUE
RESOLUT : 10	1: R-BIT
PATTERN : 63	2: RUN TIME
FLOWCTRL : OFF	3: REPEAT

◆ When R-BIT is selected, “COUNT” is displayed under “TEST MODE” to select the designated value of the number of effective received bits. Place the “ ← ” mark on “COUNT” to enter the number of bits displayed in the given list “SELECT” with the numerical keys.

◆ When RUN TIME is selected, “SEC” is displayed under “TEST MODE” to select the designated value of the measurement time.

Place the “ ← ” mark on “SEC” to enter the measurement time by the numerical keys. (Max. 99999999sec)

◆ When selecting REPEAT, “RESOLUT” which can select the specific value of the measurement unit time is displayed under “TEST MODE”.

Place “ ← ” mark on “RESOLUT” to specify the measurement time of 1 time by units of minutes. (up to 1440 minutes = 24 hours)

3. Place “ ← ” mark on “PATTERN” to select a transmitting test pattern data.

Setting	Name	Description
0	63	$2^6 - 1$ (Random code generated by generation polynomial $X^6 + X + 1$ )
1	511	$2^9 - 1$ (Random code generated by generation polynomial $X^9 + X^4 + 1$ )
2	2047	$2^{11} - 1$ (Random code generated by generation polynomial $X^{11} + X^2 + 1$ )
3	MARK	ALL 1
4	SPACE	ALL 0
5	ALT	10..
6	DBL-ALT	0011..
7	1 in 4	1000..
8	1 in 8	10000000..
9	1 in 16	1000000000000000..
A	3 in 24	010001000000000000000100..

4. Place “ ← ” mark on “FLOWCTRL” to set RTS-CTS flow control.

On: When the analyzer is in DTE mode, it transmits the data while CTS is active, and stops transmitting while non-active.

When the analyzer is in DCE mode, it transmits the data while RTS is active, and stops transmitting while non-active.

Off: Data transmission is always available.

#### ■ Relation with the PROTOCOL setting

The communication speed and transmission format(asynchronous synchronous) are determined by the setting of the “PROTOCOL” of configuration.

#### ◆ In the Case of ASYNC

Item	Meaning
S-SPEED	Transmission speed of test pattern
R-SPEED	Receiving speed of a test pattern
CHAR BIT	Character bits length of test pattern data
STOP BIT	Stop bits length of transmission test pattern data
Other setting items	Irrelevant

☞ Test pattern is divided to the designated value of CHAR BIT and a start bit and a stop bit are added to each unit. The added start bit and stop bit are not measured.

#### ◆ In the Case of SYNC BSC

Item	Meaning
S-SPEED	Transmission speed of a test pattern
R-SPEED	Receiving speed of a test pattern
CLOCK	Transmission clock
Other setting items	Irrelevant

## 5.1 Start and End a Measurement

### Start

Press [RUN] to display the BERT results screen after the results of the previous measurement cleared, and a new measurement starts.

- Transmission Transmission of the test pattern starts from the SD side when DTE is set, or from the RD side when DCE is set.

The following signals are turned on simultaneously when the transmission starts.

When DTE is set : RS, ER      When DCE is set : CS, DR, CD

- It is possible to stop updating the result display by pressing [ENTER] during measurement. However, at the time of REPEAT measurement, only the number of measurement unit time displayed at the lower part of the screen is updated.

- Receiving "SYNC SEARCH" is displayed until the initial pattern is detected and synchronization, "SYNC SEARCH" disappears and measurement starts.

- Every time [0] is pressed during a measurement operation (transmission of test pattern), a test pattern including one error bit is sent. Every time [1] is pressed, a test pattern including five errors is sent.

### End

Press [STOP] to stop the measurement. When "TEST MODE" is set to "R-BIT," "RUNTIME," the measurement is automatically stopped by satisfying each measurement continuing condition. At this time, RUN LED does not light out until [MENU] is pressed due to the continuous transmission of the test pattern.

- When the operation is stopped by the use of auto-run function, the transmission of the test pattern is stopped and RUN LED also lights out.

## 5.2 Data Use

Savail.....48	Loss.....0
R-Bit.....4426416	R-Blk.....70260
E-Bit.....196	E-Blk.....44
Bit-ER 4.43E-5	Blk-ER 6.26E-4
E-Sec 6	%E.F.S 87.500
1 REPEAT	115.2k/115.2k

Displays the number of times of measurement at the unit time. (Only at REPEAT measurement)

Name	Description	Measured Range	Note
Savail	Effective period after synchronization is first established	0~9999999(sec)	1, 2
R-Bit	Number of received bits while synchronization is maintained	0~9999999~9.99E9	1
E-Bit	Number of bit errors occurred	0~9999999~9.99E9	
Bit-ER	Bit error rate	0.00E-0~9.99E-9	
LOSS	Number of deviations from synchronization	0~9999	3
R-Blk	Number of received blocks while synchronization is maintained	0~9999999~9.99E9	4
E-Blk	Number of blocks which included bit errors	0~9999999~9.99E9	4
Blk-ER	Block error rate	0.00E-0~9.99E-9	4
E-Sec	Time when bit errors were detected during Savail	0~9999	
%E.F.S	Error-free seconds (%)	0.000~100.000(%)	5

- Establishment of synchronization : Success in receiving 32 consecutive bits of normal data
- Valid time: It counts the time as valid time in which bit error rate is under 0.1% for 1 second. When the time continued more than 10 seconds in which bit error rate is 0.1% or more, the 10 seconds are not counted as valid time. In this case, after 10 seconds passes in which bit error rate is under 0.1%, it restart to count including the 10 seconds.
- SYNC LOSS : Occurrence of at least 200 error bits among 512 consecutive bits
- 1 BLOCK LENGTH : Number of bits in one cycle of test pattern
- %E.F.S: 
$$\frac{(\text{Savail}) - (\text{E-Sec})}{(\text{Savail})}$$

- "REPEAT" mode allows you to scroll the several measured data by [▲], [▼].

Also, after pressing [F] to input the number key, the specific data can be displayed by pressing [ENTER].

- When selecting REPEAT, it is possible to print continuously in the table format and to capture data to the PC in TEXT data format. One measurement is shown by one line. From the data displayed on the present screen, the data of every 60 lines per specific 1 page is printed. Printed items will be different in every measured data.

# Chapter 6 Useful Functions

## 6.1 Trigger Function (TRIGGER)

Trigger Function is to start a specific action upon occurrence of a specific event as the trigger. A perplexing flow of data which is not easy to be analyzed. In the normal monitor operation, is analyzed on the basis of occurrence of the specific event.

### Setting

<b>MONITOR</b>	<b>SIMULATE</b>	<b>SETUP</b>
ONLINE	MANUAL	0:CONF IG
DELAY	BUFFER	1:INTERFACE
TREND	FLOW	2:TRIGGER
<b>BERT</b>	ECHO	3:CONDITION
BERT	POLLING	4:WAVE MOR
	PROGRAM	5:AUTO CONF

To select "TRIGGER," press [2] in the top menu ([MENU]).

← TRIGGER ▶	FACTOR	ACTION
<input type="checkbox"/> TRIGGER0	0:ERROR	4:BUZZER
<input type="checkbox"/> TRIGGER1	1:ERROR	5:BUZZER
<input type="checkbox"/> TRIGGER2	2:ERROR	6:BUZZER
<input type="checkbox"/> TRIGGER3	3:ERROR	7:BUZZER
SHIFT+0~3:TRIGGER DISABLE ↔ ENABLE		
F:TIMER/COUNTER SETTING		

Up to four triggers can be set. FACTOR and ACTION may be set for each trigger independently. Each trigger can be set either to be enabled or disabled.

#### Setting a trigger enable/disable

Press [SHIFT] + [0] to [3](number for trigger) for changes of setting.

e.g. Set trigger No.0 enable by pressing [SHIFT] + [0] and trigger No.2 by pressing [SHIFT] + [2].

← TRIGGER ▶	FACTOR	ACTION
<input checked="" type="checkbox"/> TRIGGER0	0:ERROR	4:BUZZER
<input type="checkbox"/> TRIGGER1	1:ERROR	5:BUZZER
<input checked="" type="checkbox"/> TRIGGER2	2:ERROR	6:BUZZER
<input type="checkbox"/> TRIGGER3	3:ERROR	7:BUZZER
SHIFT+0~3:TRIGGER DISABLE ↔ ENABLE		
F:TIMER/COUNTER SETTING		

TRIGGER

"R" " ENABLE

"□" " DISABLE

Enable trigger (R) with lower number will act first.

#### Set FACTOR

Press [0] to [3] key corresponding to the desired factor, or move the "➡" mark by the cursor keys ([▲], [▼]) and press [ENTER]. Then, the setting screen will be displayed.

← TRIGGER ▶	FACTOR	ACTION
<input checked="" type="checkbox"/> TRIGGER0	0:ERROR	4:BUZZER
<input type="checkbox"/> TRIGGER1	1:ERROR	5:BUZZER
<input type="checkbox"/> TRIGGER2	2:ERROR	6:BUZZER
<input type="checkbox"/> TRIGGER3	3:ERROR	7:BUZZER
SHIFT+0~3:TRIGGER DISABLE ↔ ENABLE		
F:TIMER/COUNTER SETTING		

← TRIGGER 0 ▶	*SELECT*
FACTOR :ERROR	0:ERROR
PRIV/MP :ON	1:CHARACTER
FRAMING :ON	2:LINE
BCF :ON	3:TR/CT MAT
BRK/ABOT:ON	4:IDLE TIME
SHORT FR:ON	5:EXTERNAL

#### Set ACTION

Press [4] to [7] key corresponding to the desired action, or move the "➡" mark by the cursor keys ([▲], [▼]) and press [ENTER]. Then, the setting screen will be displayed.

← TRIGGER ▶	FACTOR	ACTION
<input checked="" type="checkbox"/> TRIGGER0	0:ERROR	4:BUZZER
<input type="checkbox"/> TRIGGER1	1:ERROR	5:BUZZER
<input type="checkbox"/> TRIGGER2	2:ERROR	6:BUZZER
<input type="checkbox"/> TRIGGER3	3:ERROR	7:BUZZER
SHIFT+0~3:TRIGGER DISABLE ↔ ENABLE		
F:TIMER/COUNTER SETTING		

← TRIGGER 0 ▶	*SELECT*
ACTION :BUZZER	0:BUZZER
	1:STOP
	2:SAVE
	3:TIMER
	4:COUNTER
	5:TRIG SN
	6:SEND 7:OT2

### Trigger Output

When any of the trigger conditions which is set for FACTOR is satisfied, output a pulse for about 1 second from the external signal OT1 terminal.

If you wish to output a pulse only when satisfying a specific trigger condition, use "TRG OT2".

When new triggers occur during the trigger pulse output, the signal level will be HIGH level after approximately 1ms from the last trigger.

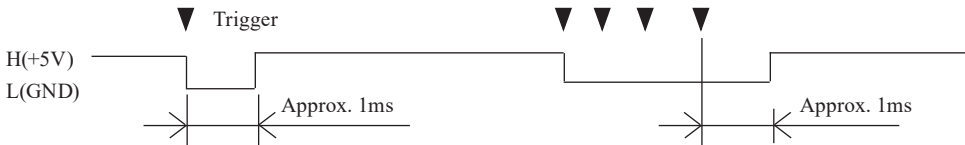

■ ERROR

← TRIGGER 0	→	*SELECT*
FACTOR : ERROR	←	0: ERROR
PRTY/MP : ON		1: CHARACTER
FRAMING : ON		2: LINE
BCC : ON		3: TM/CT MAT
BRK/ABOT : ON		4: IDLE TIME
SHORT FR : ON		

“ACTION” takes place by the generation of an error.

PRTY/MP and BCC are effective only when “NONE” has not been selected in the configuration([MENU],[0]).

PRTY/MP	Parity error or MP bit =1 or I2C acknowledge bit =1
FRAMING	Framing error
BCC	Block check code error
BRK/ABOT	Break/Abort
SHORT FR	Short frame

■ CHARACTER

← TRIGGER 0	→	*INPUT*
FACTOR : CHARACTER	←	SET 0-8
CHAR SD : 414243		CHARACTER
RD :		(00-FF, * M0-M2)
MASK W0 : *****		(HEX CODE)
W1 : *****		M0-M2=SHIFT-0-2
W2 : *****		↑ =SHIFT-F

“ACTION” takes place by the generation of a specific characters. Up to 8 characters can be set for each of SD or RD sides separately. X(Don't care), bit mask (up to 3 kinds) and flag (enter [SHIFT]+[F] ) of SDLC HDLC can also be set.

- Setting the RD side will be disabled if both SD and RD will be set by character trigger.

■ LINE

← TRIGGER 0	→	*INPUT*
FACTOR : LINE	←	SET
RS CS DR CD ER SW CI EX		PATTERN
L1 * * * * *		(0, 1, *)

“ACTION” takes place by a status of each signal line. Set the conditions with 1(H), 0(L) or X (Don't care) for the 7 lines: RS, CS, DR, CD, ER, CI and EX. The status judgment on 1, or 0 is displayed in the same way as the line state display.

- Two or more of 1/0 are set in the setting of LINE, ACTION is taken according to the agreement of all the conditions (AND conditions). ACTION is taken when the state changes from the condition disagreement to the condition agreement.
- “SQ” is only for interchanging with former models.
- EX corresponds with the external input (EXT.IN). EXT.IN is pulled up with DCSV and 10KΩ.

■ TM/CT MAT

← TRIGGER 0	→	*SELECT*
FACTOR : TM/CT	←	0: ERROR
POINT : TM0		1: CHARACTER
		2: LINE
		3: TM/CT MAT
		4: IDLE TIME

“ACTION” takes place when the timer or the counter reaches a preset value. Specify which timer (TM 0, TM 1) or counter (CT 0, CT 1) is to be used.

6.2 Timer/Counter Function

■ IDLE TIME

← TRIGGER 0	→	*SELECT*
FACTOR : IDLE TM	←	0: ERROR
IDLE TM : 0		1: CHARACTER
		2: LINE
		3: TM/CT MAT
		4: IDLE TIME

“ACTION” takes place when the idle time reaches a preset value.



■ BUZZER

← TRIGGER 0 ▶	*SELECT*
ACTION :BUZZER	0:BUZZER
	1:STOP
	2:SAVE
	3:TIMER
	4:COUNTER
	5:TRIG SW
	6:SEND 7:OT2

Buzzer sounds for about 0.3 seconds.

■ STOP

← TRIGGER 0 ▶	*SELECT*
ACTION :STOP	0:BUZZER
OFFSET :QUICK	1:STOP
	2:SAVE
	3:TIMER
	4:COUNTER
	5:TRIG SW
	6:SEND 7:OT2

Measurement stops automatically. Delay time from the occurrence of the trigger to the stop of measurement can be set with OFFSET.

- QUICK Stops the measurement immediately as trigger occurs.
- BEFORE Stops the measurement after taking in a large amount of data which exists before the trigger.
- CENTER Stops the measurement so that the same amount of data is taken in before and after the trigger.
- AFTER Stops the measurement after taking in a large amount of data which exists after the trigger.

■ SAVE

← TRIGGER 0 ▶	*SELECT*
ACTION :SAVE	0:BUZZER
OFFSET- : 0	1:STOP
OFFSET+ : 0	2:SAVE
	3:TIMER
	4:COUNTER
	5:TRIG SW
	6:SEND 7:OT2

Save some data which exists before/after the trigger satisfaction. Set the amount of data (max.9999) to save by setting OFFSET (+)(-). OFFSET + means after the trigger and OFFSET - means before the trigger.

- ☞ It saves as a file when capturing data set in OFFSET (+)(-).
- ☞ "SAVE" action does not work while processing previous "SAVE" function.
- ☞ "SAVE" process will not be completed if stopping the measurement.
- ☞ It does not write when storage device is full.

← DIRECTORY ▶	REMAIN 487MB
↑ TGSAVE00.DT 1432	08-10-01 13:54:44
↑ TGSAVE01.DT 1432	08-10-01 13:55:34
↑ TGSAVE02.DT 1432	08-10-01 13:56:24
↑ TGSAVE03.DT 1432	08-10-01 13:57:14
SELECT FUNCTION	PUSH PAGE DOWN
0:SAVE 1:LOAD 2:DELETE	

The name of trigger saved file is "TGSAVEnn.DT".

- ☞ "nn" means number which is added automatically from 00 to 99 and is in the order of trigger saved.
- ☞ If the file name is over 99 in "SAVE" ACTION, the name is overwritten as 00.
- ☞ When you press [RUN], the file name will start from 00.

Display by [LOAD/SAVE] after the measure

■ TIMER

← TRIGGER 0 ▶	*SELECT*
ACTION :TIMER	0:BUZZER
TM No :TM0	1:STOP
:START	2:SAVE
	3:TIMER
	4:COUNTER
	5:TRIG SW
	6:SEND 7:OT2

Control the timer.

Specify the timer number (TM0 or TM1) to be controlled and the type of control (START, STOP, RESTART).

📖 6.2 Timer / Counter Function

■ COUNTER

← TRIGGER 0 ▶	*SELECT*
ACTION :COUNTER	0:BUZZER
CT No :CT0	1:STOP
:INCREMENT	2:SAVE
	3:TIMER
	4:COUNTER
	5:TRIG SW
	6:SEND 7:OT2

Control the counter.

Specify the counter number (CT0 or CT1) to be controlled and the type of control (INCREMENT: +1 , CLEAR: 0).

📖 6.2 Timer / Counter Function

■ TRIG SW

← TRIGGER 0 ▶	*SELECT*
ACTION :TRIG SW	0:BUZZER
TRIG No :TRIGGER0	1:STOP
:ENABLE	2:SAVE
	3:TIMER
	4:COUNTER
	5:TRIG SW
	6:SEND 7:OT2

Set the state of another trigger when one trigger is satisfied.

- DISABLE → (ineffective)
- ENABLE → (effective)
- CHANGE → (switch "Disable"->"Enable" and vice versa)

■ SEND

← TRIGGER 0 ▶	*SELECT*
ACTION :SEND	0:BUZZER
TABLE No :00	1:STOP
RESPONSE : 0	2:SAVE
	3:TIMER
	4:COUNTER
	5:TRIG SW
	6:SEND 7:OT2

Send the registered data.

Data for sending must be set in the data table beforehand.

Delay from the occurrence of a trigger before the start of data transmission (response time) can be set in the range of 0 to 99.999 sec.

- ☞ "SEND" ACTION does not operate in the MONITOR but operates only in the SIMULATION "MANUAL" mode.

■ TRG OT2

← TRIGGER 0 ▶	*SELECT*
ACTION :OT2	0:BUZZER
	1:STOP
	2:SAVE
	3:TIMER
	4:COUNTER
	5:TRIG SW
	6:SEND 7:OT2

The pulse is output from the external signal OT2 port.

## 6.2 Timer/Counter Function(TM/CT)

The Timer/Counter Function, in conjunction with the trigger function or the simulation "PROGRAM" mode, measures the elapsed time since a specific factor occurred and counts the number of occurrences of a specific factor.

Use "Timer" 0, 1 when measuring the elapsed time since a specific factor occurred.

Use "Counter" 0, 1 when counting the number of occurrences of a specific factor.

Use "Counter" 2, 3 when counting the total number of transmission/ reception of data (max. 4294967295).

### Setting

◀TIMER/COUNTER▶	*INPUT*
TIMER 0: *10ms 1	SET TIMER0
SCALE: *10ms 1	(1-999999)
TIMER 1: *10ms 1	<DECIMAL>
SCALE: *10ms 1	
COUNTER0: 1	
COUNTER1: 1	

To select "TRIGGER," press [2] in the top menu ([MENU]). Then press [F] and select "TIMER/COUNTER SETTING."

Move "←" and set each Timer/ Counter (1-999999) and resolution (100ms, 10ms, 1ms)

### Timer Operation

1. Clears the timer to 0 and stops as soon as measurement starts.
2. Starts(0:START), stops(1:STOP) or restarts(2:RESTART) by the control information of trigger.
3. When the number on "SET" and "NOW" in Timer 0, 1 is matched, that information is sent to the trigger.
4. Restarts counting from 0, in the case of an overflow of NOW.
5. Timer will stop at the time of measurement stops.

### Counter Operation

#### ■ General purpose counter (COUNTER0,1)

1. Clears the counter to 0 as soon as measurement starts.
2. Is incremented or cleared as a result of the control condition of the trigger.
3. When the number on "SET" and "NOW" in Counter 0, 1 is matched, that information is sent to the trigger.
4. Restarts counting from 0, in the case of an overflow of NOW.

#### ■ Transmission/ reception data counter (COUNTER 2,3)

1. Clears the counter to 0 as soon as measurement starts.
2. Increments by 1 when data from SD or RD is received. (Max. 4294967295)

### Display

◀ TIME/COUNT ▶	SET	NOH
TIMER 0	[ ]	[ ]
TIMER 1	[ ]	[ ]
COUNTER0	[ ]	[ ]
COUNTER1	[ ]	[ ]
COUNTER2	SD [ ]	[ ]
COUNTER3	RD [ ]	[ ]

Preset and current values of the timers and counters can be checked by pressing [TIME/COUNT] even during measurement.

## 6.3 Timing Waveform Measurement Function(WAVE MON)

The function is to measure the timing of data as a logic analyzer through a communication channel.

Timing of communication line is displayed by waveform in time resolution of max.50n sec.

### Setting

<pre> [WAVE MONITOR] MONITOR :ON SAMPLING CLOCK:50MS TRIGGER POSITION:CENTER PUSH PAGE DOWN         </pre>	<pre> *SELECT* MONITOR MODE 0:OFF 1:ON         </pre>
--	---

To select "WAVE MON," press [4] in the top menu ([MENU]).

Set timing waveform measurement by moving the "←" mark with a cursor key.

#### SAMPLING CLOCK

<pre> [WAVE MONITOR] MONITOR :ON SAMPLING CLOCK:10MS TRIGGER POSITION:CENTER PUSH PAGE DOWN         </pre>	<pre> *SELECT* 0:50n 7:10μ 1:100n 8:20μ 2:200n 9:50μ 3:500n 0:100μ 4:1ms 6:200μ 5:2ms C:500μ 6:5ms D:1m         </pre>
--	--

Set SAMPLING CLOCK by[0] to [D].

#### TRIGGER POSITION

<pre> [WAVE MONITOR] MONITOR :ON SAMPLING CLOCK:10MS TRIGGER POSITION:CENTER PUSH PAGE DOWN         </pre>	<pre> *SELECT* 0:BEFORE 1:CENTER 2:AFTER         </pre>
--	---

Set TRIGGER POSITION in the timing waveform measurement sampling memory (for 2K sampling).

BEFORE:Stops the measurement after taking in a large amount of data before the trigger.

CENTER:Stops the measurement so that the same amount of data is taken in before and after the trigger.

AFTER :Stops the measurement after taking in a large amount of data after the trigger.

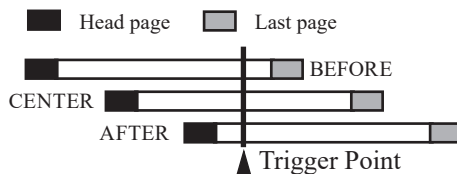

#### TRIGGER CONDITION

<pre> [WAVE MONITOR] (RS232C) [***↑] [***] [***] [***] [***] [***] [***] [***] [***] [***] SRRC DECC SSRE DDSS RRD1 TTTX 12 T PUSH PAGE UP         </pre>	<pre> *INPUT* TRIGGER CONDITION SET (0,1,*,* ,↓,↑) ↓:SHIFT+0 ↑:SHIFT+1         </pre>
---	---

Set the line state to be a trigger condition by pressing [PAGE DOWN].

[0] : 0  
 [1] : 1  
 [X] : Option ("\*"don't care)  
 [SHIFT]+[0]: Falling edge  
 [SHIFT]+[1]: Rising edge

Be sure to set edge (↑) (↓) for trigger condition.  
 "EXT" means the external input terminal "IN1".

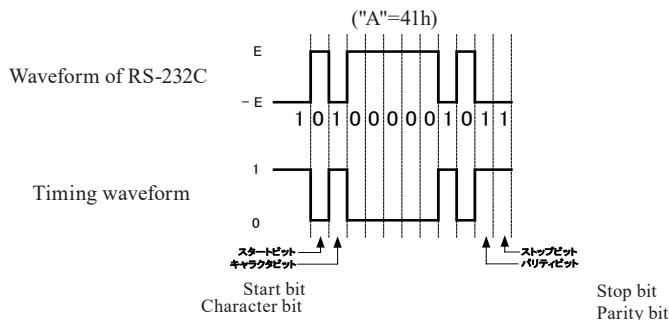

### Operation

1. Press [RUN] and start the ordinary measuring and the waveform measuring at the same time.
2. "WAVE-MON END" will be displayed on the right below of the screen when the trigger satisfied and waveform measuring ends.
3. Press [STOP] to stop measurement.

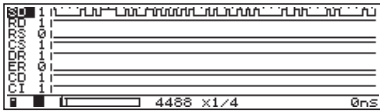
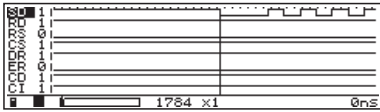
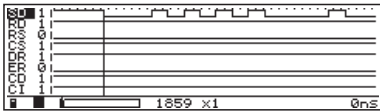

Press [TIME / COUNT] for a few times to change the screen to the timing waveform.

Display in the screen can be scrolled right and left by pressing [◀] or [▶].  
Paging of display in the screen is possible by pressing [PAGE UP] or [PAGE DOWN].

[ZOOM/CODE]: Enlarged display (zooming in),  
[SHIFT]+[ZOOM/CODE]: Reduced display (zooming out)  
Enlarges and reduces one by one in the following order.

1/64 ↔ 1/32 ↔ 1/16 ↔ 1/8 ↔ 1/4 ↔ 1/2 ↔ 1 ↔ 2 ↔ 4 ↔ 8 ↔ 16

■ Display order of signal line can be changed.

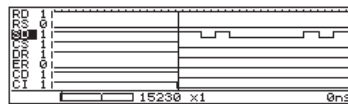
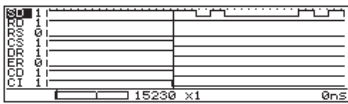

[▲],[▼]: Selection of signal line

[SHIFT]+[▲], [SHIFT]+[▼]: Movement of selected signal line

To display the signal lines not displayed, press [▲], [▼].

■ Measurement time for two points can be performed.

e.g. Measurement from falling edge of CS to start bit of SD. (trigger condition CS↓)

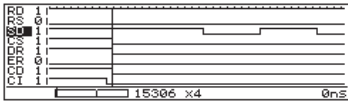

Move the cursor to falling position of CS.  
Move the cursor to the right with [3] or [SHIFT]+[▶].  
Move the cursor to the left with [2] or [SHIFT] + [◀].

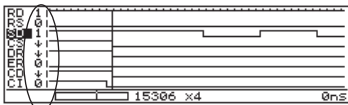

Fix the cursor by pressing [ENTER].

Line state of cursor position will be displayed.

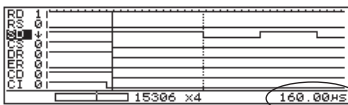

Move the cursor to SD of falling with [3] or [SHIFT]+[▶].

The time difference is 160 ns..

■ Timing search

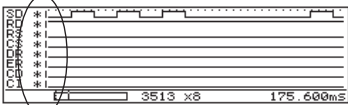

The search mode will be set after pressing [FIND].

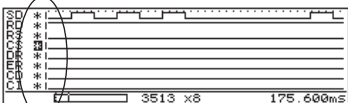

Move the "■" mark with [▲], [▼].

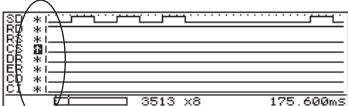

Input the conditions.

- 0 : [0]
- 1 : [1]
- ↑ : [SHIFT]+[1] (rising edge)
- ↓ : [SHIFT]+[0] (falling edge)
- \* : [END/X] (don't care)

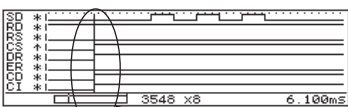

Search by [◀], [▶].

The cursor moves to the position where the condition is consisted.

## 6.4 Communication Condition Auto Setting Function(AUTO CONF)

AUTO-configuration is a function that automatically determines the conditions of communication through a communication channel.(Only for MONITOR/ONLINE)

### Setting

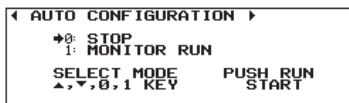

To select "AUTO CONF," press [6] in the top menu screen ([MENU]).

Move "◀" mark with the cursor key and set the process after the auto -configuration..

[0]:The operation stops and displays the communication conditions which have been determined.

The configuration settings will not be renewed by this operation.

[1]:The monitor operation starts automatically after replacing the configuration settings with the determined settings.

### Action

- [RUN] Starts an analysis to determine the monitor conditions.
  - ☰ The analysis continues until all the necessary items to be set are determined. "\*\*\*\*" on the screen indicates that the analysis is in progress, and "???" indicates that is in standby ready to run again.

- [STOP] Interrupts the process of analysis.
  - ☰ The analyzer returns to the auto-configuration setting screen regardless of the setting. (The configuration is not renewed.)

Upon the end of the analysis, the results of the analysis will be displayed or the monitor operation will start depending on the setting in step.

If "STOP" is selected in step, the following key operations are available.

[STOP] :Displays the auto-configuration screen.

[RUN] :Renews the configuration according to the result of the analysis.

〈Conditions required for auto -configuration of communication conditions〉

- ◆ Various data must be sent through the communication channel.
- ◆ A bit pattern '101' or '010' must be on the data lines.
- ◆ In the case of SDLC HDLC (NRZ/NRZI), many frames which include normal FCS must be present.
  - ☰ Over 115.2Kbps transmission rate can not be analyzed.

 Attention	Auto configuration is not 100% correct because the communication conditions of target devices vary. Please use the result as one example of setting.
---------------	--

## 6.5 Logging Function for a Long Time

Data in capture memory while monitoring can be saved automatically to the optional storage device as the appointed size of measurement log file.The file can be checked by file management function of the analyzer or optional PC link software.It is useful for rare network trouble of unknown cause by recording communication state for a long time can be stored.

### Setting

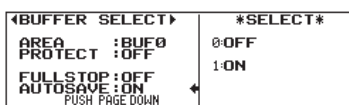

To select "CONDITION," press [3] in the top menu.

Select [0]"BUFFER SELECT"

Move "◀" by pressing [▼]. Set "FULL STOP" to "OFF", and set "AUTOSAVE" to "ON", then press [PAGE DOWN].

- ☰ Be sure that the measurement will stop when the capture buffer is full of data if "FULL STOP" is set to "ON".

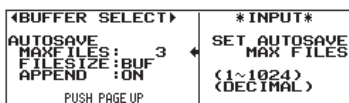

MAXFILES : sets the maximum number of files to save.

- ☰ It may not be able to save data up to the maximum number of files because of the limitation of media even if the memory card has remaining capacity.



FILESIZE : specifies the file size to save.

- ☰ "BUF" stands for the capture memory size.
- ☰ When you set the size more than the capture memory, it cannot be loaded to the analyzer. Use another tools like the PC link soft.

◀BUFFER SELECT▶ AUTOSAVE MAXFILES : 3 FILESIZE : BUF APPEND : ON PUSH PAGE UP	*SELECT* 0:OFF 1:ON
--	---------------------------

APPEND : sets how to use the existing file when saving new data.

- OFF : When starting measurement, the existing auto-saved file is deleted.
- ON : When starting measurement, the existing auto saved file is saved without deleting.

## Auto Save

### Preparation

Insert a SD card or a USB flash memory to the analyzer. <Continuous recording time reference>

Communication Speed(*1)	Storage device ( 8 GB )	Storage device ( 16 GB )(*2)
9600bps	about 480 hours	about 960 hours
1Mbps	about 5 hours	about 10 hours

\*1 : In the case that the communication on full duplex where 1KB data is being transmitted per 1ms.

- Only the SD card which LINEEYE sells as its option is guaranteed..
- The analyzer uses 4byte for one sampling of communication data.
- Make sure that you should let the battery fully charged and use AC adaptor before starting long time measurement.

 <b>Attention</b>	When the power of the analyzer is turned off during the long time measurement, not only auto -save files but also the storage device may be unable to be accessed. So do not turn off the power during measurement.
---	---

### Measurement

Press [RUN] to start measuring on the action mode previously selected. The analyzer makes files everytime when amount of "FILE SIZE" in "BUFFER SELECT" is saved to the capture memory. The filenameed "#XXXXXXX.DT"(XXXXXXX is the number which starts from 0000000) is saved to the CF card. When the number of the auto-saved files is over the max of the setting, or free space of the memory card is not enough, the old ones for the those files are deleted from the oldest file.

- When the memory card includes the auto-saved files,the message box appears at the time of starting the new measurement. If you like to delete the old files, press again to start measurement. If you would like to keep them, press , and save them to your PC or another storage device.
- If the speed exceeds about 1Mbps, AUTOSAVE function may not be able to record all the communication data. The number of times the AUTOSAVE function could not record communication data is displayed in "LOST:" at the bottom of the screen.The "LD" mark in the auto-save data indicates the part where the data could not be recorded.

#### Measuring Screen

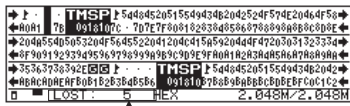

The display of lacking data

#### Data Display

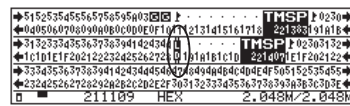

- Before it reaches the specified file number but run out the storage device, it deletes the oldest file and keeps measuring.
- Timing waveform is not recorded in the automatic save file.
- Do not turn off the power before it finish saving the all file after you push [STOP].

### How to check the automatically saved data via Wi-Fi

Using a PC software "LE file downloader" you can download to your PC via Wi-Fi the measurement log file (#XXXXXXX.DT) saved in the SD card or USB memory without stopping the measurement.

You can download the software from LINEEYE website. Please refer to the manual attached to the software for the detail.

- The expansion of time stamp is valid by the firmware V1.06 or later.

## 6.6 Automatic Start and Stop Function(AUTO RUN)

The AUTO RUN function enables you to start and stop a measurement at the specified time.

It is useful when you monitor at the specific time only.

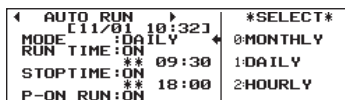

Ex.)

Starts measuring at 12:30 to 13:00  
every day

To display the "CONDITION," press [3] on the top menu screen ([MENU]).  
And then select [4] and set "AUTO RUN."

- MODE : Selects MONTHLY, DAILY and HOURLY.  
RUN TIME : Selects date, minute, and hour to start measurement following the MODE setting.  
STOPTIME : Selects date, minute, and hour to stop measurement following the MODE setting.

Once you press [RUN], it will remain standby until preset time.

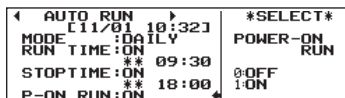

- P-ON RUN : When in the ON setting, measurement starts in ten seconds after the power on.

## 6.7 Display Screen Switching Function



### Display Switch

[DISPLAY MODE] display screen can be changed.

ASYNC • SYNC → Data display → Line state display(\*1) → BSC translation display(\*1) → Display per the frame(\*3)

HDLC • SDLC → Data display → Line state display(\*1) → Frame translation display(\*2) → Packet translation display(\*2)

ASYNC(PPP) → Data display → Line state display(\*1) → PPP translation display → PPP frame display

MODBUS • I2C • SPI → Data display → Line state display(\*1) → Frame display

- \*1: It will be displayed when selecting "CONDITION" -> [1]"RECORD & DISPLAY CONTROL" -> "LINE REC" to "BSC".  
\*2: It will be displayed, following the setting of [0]"Configuration" -> "FRAME", "PACKET".  
\*3: It will be displayed when the item of "TM STAMP" except "OFF" is selected at "RECORD & DISPLAY CONTROL" in "CONDITION" menu.



### Display Code Change

[HEX] The display codes can be switched to HEX.

To return to the former code, toggle this again.

[ZOOM/CODE] The display code can be changed in order.

→ ASCII → EBCDIC → EBCDIK → JIS7 → JIS8 → HEX → EBCD → Transcode → IPARS → Baudot

Block check codes and the like are displayed in special characters.



### Scroll

[←],[▲],[PAGE UP] Scrolls/Paging to forward (older data).

[▶],[▼],[PAGE DOWN] Scrolls/Paging to backward (later data).



### Jump

[TOP/DEL] : Jumps to the front (1 position : oldest data) of data which was saved in capture buffer.

[END/X] : Jumps to the back (the last position : latest data) of data which was saved in capture buffer.

[0]~[9],[ENTER] : Jumps specified position.

The last page is displayed if you input larger position number than measured position.

## 6.8 Translation Function

### Display Screen (Translation)

#### ■ BSC Translation Display

Only the communication control characters of the BSC procedure are displayed while decoding the transmitted/received data.

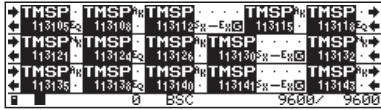

Press [3] on the top menu screen ([MENU]) and select “CONDITION.” Then select and set [1] “RECORD&DISPLAY CONTROL.” Set “ON” for “BSC.”

To switch the screen for translation display, press [DISPLAY MODE].

- ☐ Screen scrolling and jumping during the BSC translation is done by translating the data of one-screen after scroll- paging the normal data display screen. Therefore, if the one-screen data in the screen after paging includes only text characters to be omitted, the translation display does not change by performing one paging operation.
- ☐ Code systems can not be changed with [ZOOM/CODE] or [HEX].

#### ■ Frame Translation Display

The address field, control field and other information of the frame are translated and displayed, while decoding the transmitted/received data, when the “PROTOCOL” has been set to “HDLC SDLC” in the configuration menu.

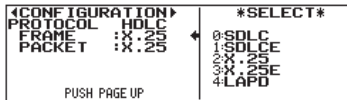

Press [0] on the top menu screen ([MENU]) and select “CONFIG.” Then press [PAGE DOWN] three times and set protocol for frame translation to the “FRAME.”

To switch the screen for translation display, press [DISPLAY MODE].

- ☐ The protocol for frame translation can be changed if you press [ZOOM/CODE].

#### 1. SDLC Frame Translation

SDLC frame translation operates by modulo 8.

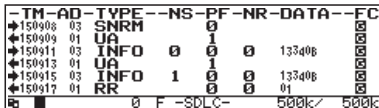

Displaying words & phrases	Meaning
“→”line	Indicates that the frame is on the SD side.
“←”line	Indicates that the frame is on the RD side.
TM	Shows the time when the frame was received. <sup>(*)</sup> 1 <sup>(*)</sup> 2
AD	Displays the contents of the address field in HEX codes.
TYPE	Displays the frame type in the form of mnemonic.
NS	Displays the frame sequence number with the decimal notation.
PF	Displays the logical value of P/F bit.
NR	Displays the frame sequence number with the decimal notation.
DATA	Displays the information field data.
FC	Displays the results of frame check.

\*1 Shows unless “TM STAMP” is in the OFF setting at “RECORD&DISPLAY CONTROL” of the “CONDITION” menu.

\*2 By pressing [SHIFT] + [TIME/COUNT], the normal time stamp display can be changed to the difference between time stamps display.



## 2. SDLC frame translation

SDLC frame translation operates by modulo 128.

## 3. X.25 frame translation

X.25 frame translation operates by modulo 8.

	TM	AD	TYPE	NS	PF	NR	DATA	FC
▶132151	03		SABM		0			0
◀132152	01		UA		1			0
▶132155	03		INFO	0	0	0	133406	0
▶132201	01		UA		1			0
▶132206	03		INFO	1	0	0	133406	0
▶132211	01		RR		0		01	0
0 F -X.25- 500k/ 500k								

## 4. X.25E frame translation

X.25 frame translation operates by modulo 128.

## 5. LAPD frame translation

\*1 Shows unless "TM STAMP" is in the OFF setting at "RECORD&DISPLAY CONTROL" of the "CONDITION" menu.

	TM	SAP	TE	CR	TYPE	NS	PF	NR	FC
▶133056	0		0	1	UI		1		0
◀133057	0	57	0						0
▶133057	0	1	1	1	UI		1		0
▶133058	0	0	0	0	RR				0
▶133100	0	65	1		INFO	1	0	24	0
▶133101	0	16	0		(13)			1	0
14 F -LAPD- 500k/ 500k									

Displaying words & phrases	Meaning
"→"line	Indicates that the frame is on the SD side.
"←"line	Indicates that the frame is on the RD side.
TM	Shows the time when the frame was received. (*1) (*2)
SAP	Displays the value of service access point identifier with the decimal notation.
TE	Displays the value of the termination point identifier of the terminal with the decimal notation.
CR	Displays the value of COMMAND RESPONSE display bit.
TYPE	Displays the frame type in the form of mnemonic.
NS	Displays the frame sequence number with the decimal notation.
PF	Displays the logical value of P/F bit.
NR	Displays the frame sequence number with the decimal notation.
FC	Displays the results of frame check.

\*2 By pressing [SHIFT] + [TIME/COUNT], the normal time stamp display can be changed to the difference between time stamps display.



## ■ Packet Translation Display

Translation of the packet header section in the text message is displayed, while decoding the transmitted/received data, when the “PROTOCOL” has been set to “HDLC SDLC.”

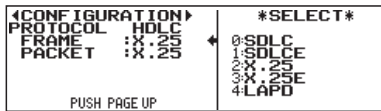

Press [0] on the top menu screen ( [MENU] ) and select “CONFIG.” Then press [PAGE DOWN] three times and set “PACKET.”

◆ To switch the screen for translation display, press [DISPLAY MODE].

☰ To change the protocol for packet translation, press [ZOOM/CODE].

### 1. X.25 Packet Translation Display

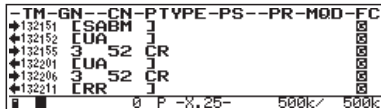

Displaying words & phrases	Meaning
“→”line	Indicates that the frame is on the SD side.
“←”line	Indicates that the frame is on the RD side.
TM	Shows when the packet was received. <sup>(*)</sup> <sup>(*)2</sup>
GN	Indicates the logic channel group number with the decimal notation.
CN	Indicates the logic channel number with the decimal notation.
P-TYPE	Indicates the packet type in mnemonic.
PS	Indicates the packet transmission sequence number with the decimal notation.
PR	Indicates the packet transmission sequence number with the decimal notation.
M	Indicates the logical values of more data bit.
Q	Indicates the logical values of qualifier bit.
D	Indicates the logical values of transmission verification bit.
FC	Displays the results of frame check.

\*1 Shows unless “TM STAMP” is in the OFF setting at “RECORD&DISPLAY CONTROL” of the “CONDITION” menu.

\*2 [SHIFT] + [TIME/COUNT] changes time display from the normal display to the difference display.

### 2. LAPD Packet Translation Display

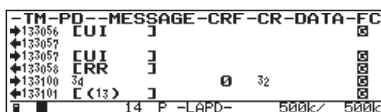

Displaying words & phrases	Meaning
“→”line	Indicates that the frame is on the SD side.
“←”line	Indicates that the frame is on the RD side.
TM	Shows the time when the packet was received. <sup>(*)</sup> <sup>(*)2</sup>
PD	Displays the protocol identifier with the hexadecimal notation.
MESSAGE	Displays the contents separately for message type in the form of mnemonic.
CRF	Displays the value of nominal number flag.
CR	Displays the value of nominal number with HEX.(Maximum 2 octet)
DATA	Displays the first five bytes of the information field data in HEX codes.
FC	Displays the results of frame check.

\*1 Shows unless “TM STAMP” is in the OFF setting at “RECORD&DISPLAY CONTROL” of the “CONDITION” menu.

\*2 [SHIFT] + [TIME/COUNT] changes time display from the normal display to the difference display.

■ Frame display screen of ASYNC

Displays the data of ASYNC protocol per the frame.

It is valid only when "PROTOCOL" is "ASYNC" and the time stamp function is enabled.

After measuring the data, the frame display screen can be shown by pressing [DISPLAY MODE] several times.

- ☞ It will be displayed when the item of "TM STAMP" except "OFF" is selected at "RECORD & DISPLAY CONTROL" of "CONDITON" menu.
- ☞ When it is ASYNC, frames are separated by the idle time more than that of set in the "FRM TIME" item of "CONFIG" or by the character detection set in "FRM END" item, Please set these properly.

Normal data display screen

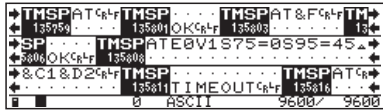

Display per a frame (Normal time stamp)

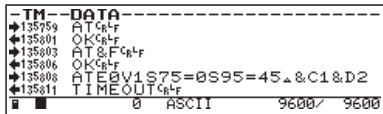

The screen can be changed to the frame data display screen by pressing [DISPLAY MODE] several times.

- ☞ In this screen, the display code of the data can be changed by pressing [ZOOM/CODE] or [HEX/CHAR].However, the data that are displayed in special characters like BCC or the data of which the error was detected, are displayed as normal data.(HEX selected by [CODE] key is same as HEX by [HEX] key.)

Display per a frame (Display of difference between two time stamps)

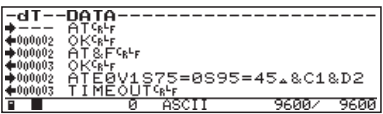

After the measurement, Normal time stamp can be changed to Difference between time stamps by [SHIFT]+[TIME/COUNT].

■ PPP Translation

The protocol value, code in LCP packet, identifier and other information of the frame are translated and displayed.

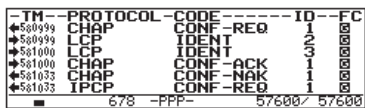

This screen is displayed only when “PROTOCOL” has been set to “PPP.”

Displaying words & phrases	Meaning
“→”line	Indicates that the frame is on the SD side.
“←”line	Indicates that the frame is on the RD side.
TM	Shows the time when the frame was received. (*1) (*2)
PROTOCOL	Translates and displays the protocol value.
CODE	Translates and displays the code field value.
ID	Displays the value of identifier field as decimal figure.
FC	Displays the results of frame check.

\*1 Shows unless “TM STAMP” is in the OFF setting at “RECORD&DISPLAY CONTROL” of the “CONDITION” menu.

\*2 On the time display, by pressing [SHIFT] + [TIME/COUNT] the normal display can be changed to the difference display.

◆ The analyzer translates all bits of ACCM as 0.

(Example) All bits of ACCM are ON (1) between communications equipment.

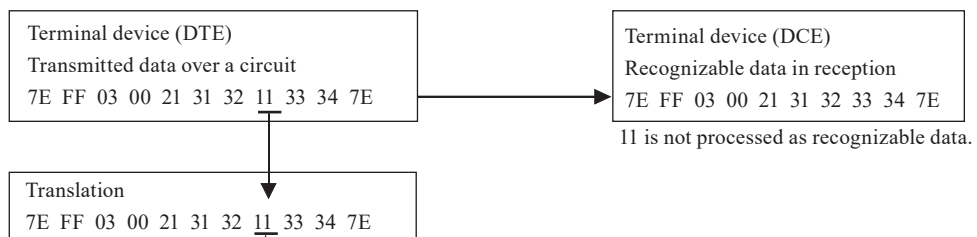

When data (7E FF 03 00 21 31 32 11 33 34 7E) is sent on the circuit as shown above, only 11 from received data is not processed as recognizable data; However, the analyzer translate 11 as data.

■ PPP Frame Display

The time stamp on reception of the frame and the contents of the data are displayed. PPP frame display makes it to check overall data exchange and communication.

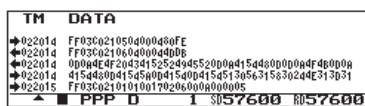

This screen is displayed only when “PROTOCOL” has been set to “PPP.”

Displaying words & phrases	Meaning
“→”line	Indicates that the frame is on the SD side.
“←”line	Indicates that the frame is on the RD side.
TM	Shows the time when the frame was received. (*1) (*2)
DATA	Displays the data.

\*1 Shows unless “TM STAMP” is in the OFF setting at “RECORD&DISPLAY CONTROL” of the “CONDITION” menu.

\*2 By pressing [SHIFT] + [TIME/COUNT], the normal time stamp display can be changed to the difference between time stamps display.

## 6.9 Retrieval Function

The retrieval function enables you to find specific data among the vast amount of data recorded in the capture memory during monitoring. It also enables you to count the number which satisfies a particular condition.

### Setting

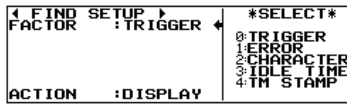

To display the retrieval condition setting screen, press [SHIFT]+[FIND] in the display mode.

Move "←" by [▲], [▼] and set retrieval Factor and Action.

#### Setting of FACTOR

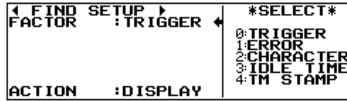

**TRIGGER:** Data which satisfies the trigger condition (FACTOR) is retrieved. TRIGGER is not retrieved in the case the trigger condition is "TM/CT"



**ERROR:** Retrieve errors which are set "ON".  
 [i] Error items are same as trigger errors.  
 [i] PRTY/MP and BCC are enabled only when items except "NONE" have been set in CONFIGURATION.

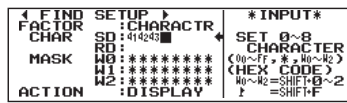

**CHARACTER:** Sets character string to be retrieved separately for each of SD and RD sides up to 8 characters. Don't care (X) and flag ([SHIFT]+[F]) of SDLC HDLC can be set.



**IDLE TM:** Retrieve idle time which is more than preset value.  
 [i] The setting unit of idle time for retrieval is the same as the unit of idle time for measurement.

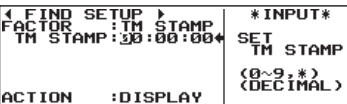

**TM STMP:** Retrieve specified time stamps. Time stamp is possible part of the designate time to be specified as "don't care" with [END/X]. If an upper digit is specified as "don't care" the lower digit is also sought as "don't care."  
 [i] The unit of retrieval setting of time stamp is done in the format as the time stamp setting unit.

Example of entry	Time to search
15:48:20 (HMS form at)	15hours 48min. 20sec.
07:16:52 (DHM form at)	7th 16hours 52min.
07:1*:** (DHM form at)	7th 10hours 00min. to 7th 19hours 59sec.

### 6.11 Recording Function to Measure Additional Information

#### ACTION

- [0]:DISPLAY Data which satisfies the retrieval condition is displayed at the top line of the screen.
- [1]:COUNT The count, which is the number of times the retrieval condition was satisfied, is displayed in the function display section.

### Retrieve

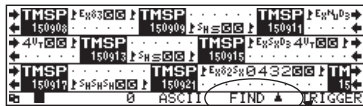

When the setting is finished, press [FIND] to return to the data display screen.

- Part a:Indicates the direction of retrieval. Switch by [▲], [▼].  
 "▲"(forward retrieval):Retrieves previous (older) data, including the data display screen.  
 "▼"(backward retrieval):Retrieves rearward (new) data, including the data display screen.
- Part b:The setting contents of "FACTOR."Switch by [▲], [▼].

TRIGGER←→ERROR←→CHARACTER←→IDLE TM←→TM STAMP

To start for retrieval, press [ENTER] .

On "DISPLAY" selected at "ACTION":

- If data which satisfies the retrieval condition is found, the data is displayed at the top of the screen.
- If data which satisfies the retrieval condition is not found, the message "NOT FOUND" is displayed.
- Then, the retrieval mode will stop.

On "COUNT" selected at "ACTION":

The number of data pieces which satisfy the retrieval condition are counted. When all the data have been scanned, the results of the retrieval are displayed. Then, the retrieval mode will stop.

- ☐ The retrieval operation for the same condition can be repeated by pressing [FIND],[ENTER]. Data which subsequently satisfy the condition are displayed at the head on the data display screen. (The retrieval operation starts with the data piece next to that at the head of the page currently on screen.)

## 6.10 Bit Shift Function

This function shifts the separation of characters of received data bit by bit, to find errors such as deviations from the character-synchronization of the serial data.

When the characters are displayed on the data display screen, press [SHIFT]+[◀]. Then, the character separation is shifted one bit from the lower bit to the upper bit.

(This operation affects the display only, and the data in the buffer memory is not shifted.)

- ☐ A mark bit ('1') is added to the lowest bit position where continuity of the data is broken, such as the head character of a frame.
- ☐ The bit shift is applied only to the screen on which data is presently displayed.
- ☐ Successive bit shifts can be made up to the number of bits constituting a character.
- ☐ Press [SHIFT]+[▶]. And the character separation is shifted one bit from the lower bit to the upper bit.
- ☐ The scroll paging operation turns the screen to the normal display without a bit shift.

e.g.) CODE: EBCDIC, bit length 8

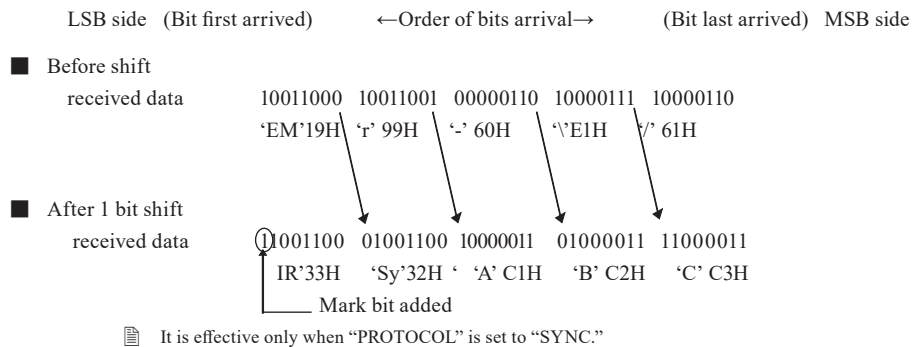

## 6.11 Recording Function to Measure Additional Information ( Idle Time, Time Stamp etc. )

This section explains the setting of the additional information along with the data transmitted and received during measuring.

Measuring and recording are carried out according to the conditions being set before the measurement.

After the end of the measurement, the data is also displayed according to the initial setting, regardless of the conditions being set afterwards.

### Idle Time Display Function

Idle time which is in mark state (not sending data) is measured.

- At first, to select "CONDITION," press [3] on the top menu screen ( [MENU] ). Next, to select "RECORD&DISPLAY CONTROL," press [1]. Then, move the " ← " mark to "IDLE TM."

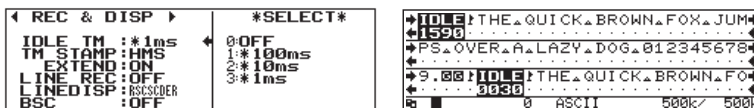

Indicates that there was an idle time of 300 to 309ms. (\*In the case of Unit: 10mS)

Item	Description	Range of Value
OFF	The idle time will not be recorded	
100ms	The idle time will be recorded in 100msec (time resolution).	0 to 999.9sec
10ms	The idle time will be recorded in 10msec (time resolution).	0 to 99.99sec
1ms	The idle time will be recorded in 1msec (time resolution).	0 to 9.999sec

- ☐ The following is regarded as idle time regardless of whether or not data is included: the time taken to establish synchronization in synchronized communication, and the time before a specific address is received in HDLC mode,
- ☐ In the case of low channel speed (9600 bps or below), there may be differences between the real idle time and the displayed idle time.
- ☐ "OVER" is displayed when the range of value is exceeded.

## Time Stamp Function

This function can record the time, when the top character of each frame transmitted through on the communication channel is received, into the buffer memory, and can display it.

- At first, to select “CONDITION,” press [3] on the top menu screen ( [MENU] ).Next, to select “RECORD&DISPLAY CONTROL,” press [1].Then, move the “ ← ” mark to “TM STAMP.” Set “EXTEND : ON” to have the extended time stamp.

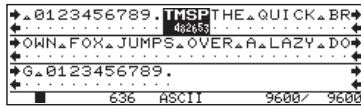
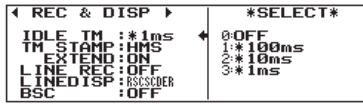

Indicates that last data was received at 48min 32.86sec.  
(\*In the case MS10m is set.)

The expansion of time stamp is valid by the firmware V1.06 or later.

Item	Description	
	EXTEND=OFF	EXTEND=ON
OFF	The time stamp is inactive.	
DHM	The time when a frame was received is set in "day, hour ,minute."	The time when a frame was received is set in "year, month, day, hour, minute."
HMS	The time when a frame was received is set in "hour, minute , second."	The time when a frame was received is set in "month, day, hour, minute , second."
MS10m	The time when a frame was receive is set in "minute , second , 10m s ."	The time when a frame was receive is set in "day, hour, minute , second , 10m s ."

9.3 Frame

## Line State Display Function

The logical states (timing form) of control lines and the data of SD/RD (one line for each) are displayed simultaneously.

- At first, to select “CONDITION,” press [3] on the top menu screen ( [MENU] ). Next, to select “RECORD&DISPLAY CONTROL,” press [1]. Then, move the “ ← ” mark to “LINE REC” and set "LINE REC" to "ON".

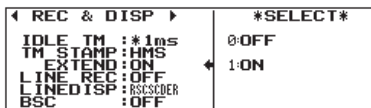

- Select “LINEDISP” with [▼], and then select the line state on the line state display.

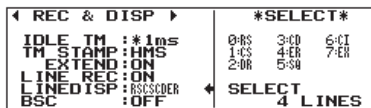

Four lines can be selected for the line state display.  
Enter the corresponding number to select the line state.

- Press [DISPLAY MODE] to switch the screen for line state display.

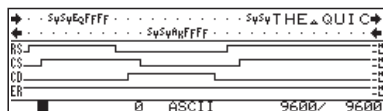

Display line state which makes LED lights on as "H", and which makes LED lights out as "L".

“EX” displays the logic state of TTL level which is input from external signal input/ output terminal, "TRIGGER IN1".  
“SQ”is for the future use and will not be displayed.



# Chapter 7 Data Usage

The printing function enables it to continuously printout data to a Printer/SD card/USB flash in various formats. The hard copy printing of the screen image can also be obtained.

## Connection to a Printer

- Connect AUX(RS-232C) port of the Analyzer and the printer in the appropriate RS-232C cable.
  - ☞ Use the optional cable LE2-8P to use the optional printer "DPU-414".

## Setting for Print out

- To select "CONDITION", press [3] on the top menu. To select "PRINT OUT CONDITION" in the setup window, press [2]. Then, move the "←" mark by [▲], [▼] to select each item.

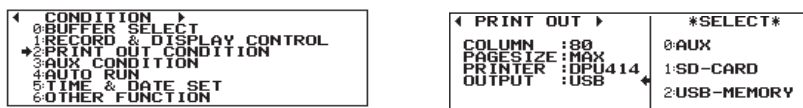

Item	Description	Setting range
COLUMN	Number of digits per line	40, 80, 136
PAGESIZE	Mode of printing page	MAX : Continuous printing 66 : Feed 6 lines after printing 60 lines
PRINTER	Printer control code(*1)	DPU-414, DPU-411, DPU-412, ESC/P24-81, PC-PR201H
OUTPUT	Place to output the text data	SD : SD card(*2) USB : USB flash memory(*2) AUX : AUX (RS-232C) port
EOF	Adding EOF code (1Ah)	Select when you use RS-232C. OFF : For normal use ON : When capturing data in a PC

\*1: It is not necessary to set "PRINT OUT CONDITION" for normal use. To print the screen image, logic analyzer waveform or statistic graphs, set the appropriate items for your printer. To capture the screen images BMP file using the PC link software, select "DPU-414".

\*2: When you print the text data, it automatically names the file "DDHHMMSS.TXT" (DDHHMMSS is the time you make the file). When you print the screen image, logic analyzer waveform or statistic graphs, it does not make the text file automatically.

If you select "OUTPUT" to "AUX", you need to set [3]"AUX CONDITION" at CONDITION menu.

Item	Setting	
SPEED	Speed (bps)	9600, 19200, 38400, 57600, 115200, 230400
CHAR BIT	Data bit length	7 bits, 8 bits
PARITY	Parity bit for AUX	NONE, ODD, EVEN
X-CONT	Xon/Xoff Flow control	OFF : RTS-CTS Flow control only
		ON : Xon/Xoff and RTS-CTS Flow control

- Example of DPU-414 setting

Analyzer setting:

"PRINT OUT CONDITION"; COLUMN : 80, PAGESIZE : MAX, PRINTER : DPU-414, OUTPUT : AUX, EOF : OFF  
"AUX CONDITION"; SPEED : 9600, CHRA BIT : 8, PARITY : NONE, X-CONT : OFF

DPU-414 setting (setting which is different from the factory setting):

- “Soft DIP SW1” NO.1 : OFF serial
- “Soft DIP SW2” NO.1 : OFF 80 column
- “Soft DIP SW3” NO.5-8 : [OFF ON ON ON] 9600bps

☞ For more details, please read the instruction manual of DPU-414,

## 7.1 Hard Copy Printing

It is possible to print the screen image by DPU-414 or other printers which supports the escape codes for LINEEYE analyzer.

Press [SHIFT]+[PRINT] to output the screen image to the printer via AUX port.

- Select the printer at "PRINTER" in the SYSTEM menu -> "PRINT OUT CONDITION".

## 7.2 Normal Printing

### To print measured data

- Press [DISPLAY MODE] and arrange the data to the format in which you wish to print the data.
- Display the measured data which you wish to start printing on the screen by using the page/scroll operation or the search function.
- Press [PRINT], and the FUNCTION display section will show "PRINT". Enter the range of data to be printed in 5-digits in decimal.

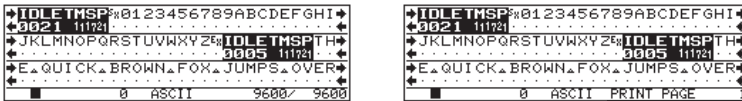

- Enter 99999 in the range of printing if you want to print till the last data.

- Press [STOP] to stop printing data.

- Press [ENTER]. The measured data of the specified number of pages will be printed. The measured data stored in the capture buffer will be printed in the format, which corresponds to the screen display mode.

- If the range of printing is set greater than the measured data size, the operation will stop after printing the last data.
- You can stop printing by pressing [STOP] key. But the data which are already processed will be printed.
- To save in a CF card, insert it to the CF card slot.
- During RUN, printing can not be obtained.

### Printing Format For The Measured Data

#### Data Display Mode

Information of one character of the measured data is printed in two lines in both hexadecimal code form and characters using 4-character space.

<Display>

SX	A	B	EX
----	---	---	----



<Printout>

02	41	42	03
SX	A	B	EX

HEX (hexadecimal)  
Character

- In case the character code is not defined or "△" (space code), nothing is printed in the character code printout line.
- If there is no data, "-" is printed in the HEX printout line.
- Time information and line state of signal lines will be printed as following.

Idle time [ I D L E ]	Time stamp [ T M S P ]	Line state H "11"
[ 0 0 2 0 ]	[ 0 5 1 7 3 5 ]	L "00"
		H→L "10"
		L→H "01"

- If characters of the measured data have special attribute, symbols as shown below will be printed in the character code printout line.

Display	Meaning
?1	Parity error
?2	Framing error
?3	Parity & framing error
?4	Over run error
?5	Short frame
??	BCC (error)
{ }	BCC (normal)
^^	Flag
BB	Break
AA	Abort
##	MP bit

Display	Meaning
>>	Start Sequence
>>	Stop Sequence
##	Acknowledge
=>	Send on master side (write)
<=	Receive on master side (read)
a	Acknowledge
n	Not Acknowledge



◇ X.25 packet translation

Display	Meaning
SD	Indicates that the packet is on the SD side.
RD	Indicates that the packet is on the RD side.
TIME	Shows the time when the packet was received.
GN	Displays the logical channel group number in decimal figure.
CN	Displays the logical channel group number in decimal figure.
P-TYPE	Displays the packet type in mnemonic.
PS	Displays the packet transmission sequence number in decimal figure.
PR	Displays the packet transmission sequence number in decimal figure.
M	Displays the value of more data bit.
Q	Displays the value of quality bit.
D	Displays the value of transmission confirmation bit.
FC	Displays the results of frame check.

◇ LAPD packet translation

Display	Meaning
SD	Indicates that the packet is on the SD side.
RD	Indicates that the packet is on the RD side.
TIME	Shows the time when the packet was received.
PID	Displays the protocol identifier in HEX code.
MS	Displays the contents of each message type in mnemonic.
CRF	Displays the value of the call reference flag.
CR	Displays the call reference value in HEX code. (Maximum 2 octet)
DATA	Displays the first 5 bytes of data in the information field in HEX code.
FC	Displays the results of frame check.

◇ Printing Example of PPP Translation

```

*=[LE-3500R]====[2015-03-05 14:33:40]*
* Model      : LE-3500R *
* Version    : 1.11 *
* Extension  : Standard *
* Serial No. : xxxxxxxx *
* Start time : 2012-05-16 21:51:08 *
* Stop time  : 2012-05-16 21:52:07 *
*-----*
* MONITOR DATA (PPP FRAME DUMP) *
* PROTOCOL : PPP *
* S-SPEED  : 57600 R-SPEED : 57600 *
* CODE     : HEX FCS : FCS16 *
* IDLE TM  : 1ms TM STAMP: MS10m *
* PRINT CODE : ASCII *
*-----*
-----TM-----PROTOCOL-CODE-----ID-FC-----DATA-----
SD: 58 09 43 LCP CONF-REQ 0 G 00320206000000000506289B6DD2070208020D03
RD: 58 09 43 LCP CONF-REQ 1 G 002010405F402060000000000305C22305070208
RD: 58 09 84 LCP CONF-REQ 0 G 000600030B1104064E
SD: 58 09 84 LCP CONF-ACK 1 G 002010405F402060000000000305C22305070208
SD: 58 09 85 LCP CONF-REQ 1 G 002B202060000000000506289B6DD2070208021317
RD: 58 09 85 LCP CONF-ACK 1 G 002B202060000000000506289B6DD2070208021317
RD: 58 09 98 LCP CONF-REQ 1 G 0021107D1A3C2B8E4ADCE51A19A8B4C4C1E9A6E
SD: 58 09 98 LCP IDENT 2 G 00122898DD24D635241536852E3030
SD: 58 10 00 LCP IDENT 3 G 001E2898DD24D635241532D312D450534FE5F
SD: 58 10 00 CHAP CONF-ACK 1 G 0034108408E8379CF6B9E3D80806FE74295C70
RD: 58 10 33 CHAP CONF-NAK 1 G 0000500
RD: 58 10 33 IPCP CONF-REQ 1 G 001020206002D0F010306D29F828
SD: 58 10 33 IPCP CONF-REQ 1 G 00041206000001
SD: 58 10 33 IPCP CONF-REQ 5 G 00280206002D0F0103060000000810600000000
SD: 58 10 34 IPCP CONF-ACK 1 G 001020206002D0F010306D29F828
RD: 58 10 46 LCP PROT-REQ 2 G 001080FD10400A120600000001
RD: 58 10 47 IPCP CONF-REQ 5 G 0010820600000008040600000000
SD: 58 10 47 IPCP CONF-REQ 6 G 00103206002D0F0103060000000810600000000
RD: 58 10 57 IPCP CONF-NAK 6 G 001080306D28B420D8106CAEF71128306CAEF711A
SD: 58 10 58 IPCP CONF-REQ 7 G 001020206002D0F010306D28B420D8106CAEF711A
RD: 58 10 69 IPCP CONF-ACK 7 G 001020206002D0F010306D28B420D8106CAEF7112
SD: 58 10 83 IP (45) 0 G 01480725000080111E03D28B420D8106CAEF711A
SD: 58 14 82 IP (45) 0 G 01480725000080111E03D28B420D8106CAEF711A
SD: 58 23 69 IP (45) 0 G 0038072700008011E2F0D28B420D8106CAEF711204D2
SD: 58 23 85 IP (45) 0 G 009C4F154000F711EAD0CAEF7112D28B420D8106CAEF711A
SD: 58 23 89 IP (45) 0 G 0030072840008008EBCDD28B420D8106CAEF711A
RD: 58 24 03 IP (45) 0 G 0030072840008008EBCDD28B420D8106CAEF711A
SD: 58 24 04 VJUTCP/IP (45) 0 G 00280724A0008000EBCDD28B420D8106CAEF711A
SD: 58 24 05 VJUTCP/IP (70) 0 G 28ED02474554202F20485454502F31E2310D0A41
    
```

◇ Printing Example of Packet

```

*=[LE-3500R]====[2015-03-05 14:33:40]*
* Model      : LE-3500R *
* Version    : 1.11 *
* Extension  : Standard *
* Serial No. : xxxxxxxx *
* Start time : 2012-05-16 21:51:08 *
* Stop time  : 2012-05-16 21:52:07 *
*-----*
* MONITOR DATA (X.25 PACKET) *
* PROTOCOL : HDLC *
* S-SPEED  : 2.048M R-SPEED : 2.048M *
* CODE     : EBCDIC FCS : FCS16 *
* FORMAT   : NRZ CLOCK : ST1 *
* S-ADDR   : * R-ADDR : * *
* IDLE TM  : 1ms TM STAMP: MS10m *
* PRINT CODE : ASCII *
*-----*
-----TM-----GN-----CN-----P-TYPE-----PS-----PR-----MOD-----FC-----DATA-----
SD: 20 54 53 3 201 (05) G C5C5E8C5F1
RD: 20 54 63 3 197 DT 0 3 011 G F7F2F0F0
SD: 20 54 64 3 201 (05) G C5C5E8C5F2
RD: 20 54 66 [RNR ] G
SD: 20 54 66 3 201 (05) G C5C5E8C5F1
RD: 20 54 77 3 197 DT 0 3 011 G F7F2F0F0
SD: 20 54 77 3 201 (05) G C5C5E8C5F2
RD: 20 54 79 [RNR ] G
SD: 20 54 80 3 201 (05) G C5C5E8C5F1
RD: 20 54 90 3 197 DT 0 3 011 G F7F2F0F0
SD: 20 54 91 3 201 (05) G C5C5E8C5F2
RD: 20 54 92 [RNR ] G
SD: 20 54 93 3 201 (05) G C5C5E8C5F1
RD: 20 55 03 3 197 DT 0 3 011 G F7F2F0F0
SD: 20 55 04 3 201 (05) G C5C5E8C5F2
RD: 20 55 05 [RNR ] G
SD: 20 55 06 3 201 (05) G C5C5E8C5F1
RD: 20 55 16 3 197 DT 0 3 011 G F7F2F0F0
SD: 20 55 17 3 201 (05) G C5C5E8C5F2
RD: 20 55 18 [RNR ] G
SD: 20 55 19 3 201 (05) G C5C5E8C5F1
RD: 20 55 29 3 197 DT 0 3 011 G F7F2F0F0
SD: 20 55 30 3 201 (05) G C5C5E8C5F2
RD: 20 55 31 [RNR ] G
SD: 20 55 32 3 201 (05) G C5C5E8C5F1
RD: 20 55 42 3 197 DT 0 3 011 G F7F2F0F0
    
```

◇ Printing Example of PPP Dump

```

*=[LE-3500R]====[2015-03-05 14:33:40]*
* Model      : LE-3500R *
* Version    : 1.11 *
* Extension  : Standard *
* Serial No. : xxxxxxxx *
* Start time : 2012-05-16 21:51:08 *
* Stop time  : 2012-05-16 21:52:07 *
*-----*
* MONITOR DATA (PPP FRAME DUMP) *
* PROTOCOL : PPP *
* S-SPEED  : 57600 R-SPEED : 57600 *
* CODE     : HEX FCS : FCS16 *
* IDLE TM  : 1ms TM STAMP: MS10m *
* PRINT CODE : ASCII *
*-----*
-----TM-----FC-----DATA-----
SD: 58 09 43 G FF030C21010000320206000000000506289B6DD2070208020D03061104064E
RD: 58 09 82 G FF030C2101002010405F402060000000000305C223050702080213090300
RD: 58 09 84 G FF030C21010000000000000305C223050702080213090300
SD: 58 09 84 G FF030C2101002010405F4020600000000000305C223050702080213090300
SD: 58 09 85 G FF030C210100202060000000000506289B6DD20702080213170143847A99
RD: 58 09 85 G FF030C210100202060000000000506289B6DD20702080213170143847A99
SD: 58 09 98 G FF030C210100202060000000000506289B6DD20702080213170143847A99
RD: 58 09 98 G C22301010021107D1A3C2B8E4ADCE51A19A8B4C4C1E9A6E81733531312E6B
SD: 58 09 99 G C02100200122898DD24D635241536852E3030
SD: 58 10 00 G C021002001E2898DD24D635241532D312D450534FE5F454495F435542
SD: 58 10 00 G C2230210004108408E8379CF6B9E3D80806FE74295C706C7573315F86E1
RD: 58 10 33 G C2230301005000
RD: 58 10 33 G 8021010100100206002D0F010306D29F828
SD: 58 10 33 G 80FD104000A12060000001
SD: 58 10 33 G 8021010500280206002D0F0103060000000810600000000803
SD: 58 10 34 G 8021020100100206002D0F010306D29F828
RD: 58 10 46 G FF030C210802010800FD10400A120600000001
RD: 58 10 47 G 80210405001082060000000008040600000000
SD: 58 10 47 G 8021010800100206002D0F01030600000008106000000008030600000000
RD: 58 10 57 G 8021030600108206002D0F010306D28B420D8106CAEF71128306CAEF711A
RD: 58 10 58 G 8021010700100206002D0F010306D28B420D8106CAEF71128306CAEF711A
RD: 58 10 69 G 8021020700100206002D0F010306D28B420D8106CAEF71128306CAEF711A
SD: 58 10 83 G 21450001480725000080111E03D28B420D8106CAEF711A044043013424740108
SD: 58 14 82 G 21450001480725000080111E03D28B420D8106CAEF711A044043013424740108
SD: 58 23 69 G 2145000038072700008011E2F0D28B420D8106CAEF711204D200350027D8490014
SD: 58 23 85 G 214500009C4F154000F711EAD0CAEF7112D28B420D8106CAEF711A0089A0014
SD: 58 23 89 G 2145000030072840008008EBCDD28B420D8106CAEF711A005025FC8270000
RD: 58 24 03 G 2145000030072840008008EBCDD28B420D8106CAEF711A005025FC8270000
SD: 58 24 04 G 2F450000280724A0008000EBCDD28B420D8106CAEF711A005025FC8270000
    
```



◇ Printing Example of Trend Data(graph)

<< Trend List >> 2008/09/17 15:48:27

EVENT :DATA  
RESOLUTION:10min  
MONITOR:2008/09/17 13:00 - 09/17 15:39

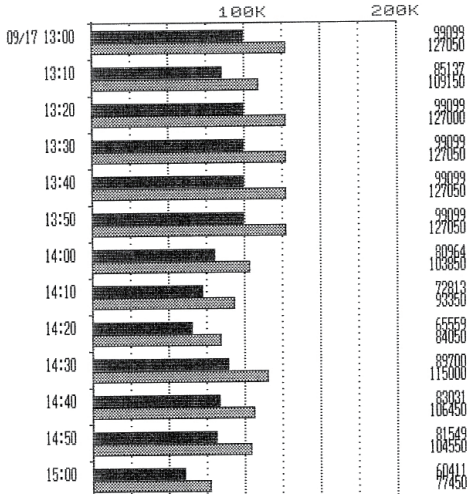

◇ Printing Example of WAVE MON

<< Timing List >> 2008-09-17 17:24:54

Position: 3852  
Trigger : 3873 Clock:50ns  
Cursor : 4062 Zoom :x1  
Marker : 3976 C-M :4.30us

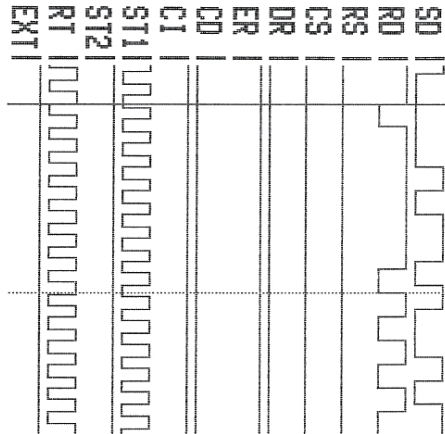

◇ Printing Example of Trend Data(text)

<< Trend List >> 2008/09/17 15:43:50

EVENT :DATA  
RESOLUTION:10min  
MONITOR:2008/09/17 13:00 - 09/17 15:39

Time	S	D	R	D
09/17 13:00	99099	127050		
13:10	85137	109150		
13:20	99099	127000		
13:30	99099	127050		
13:40	99099	127050		
13:50	99099	127050		
14:00	80964	103850		
14:10	72813	93350		
14:20	65559	84050		
14:30	89700	115000		
14:40	83031	106450		
14:50	81549	104550		
15:00	60411	77450		
15:10	59865	76700		
15:20	99060	127050		
15:30	95394	122300		

◇ Printing Example of BERT

```

*=[LE-3500R]===[2015-03-05 14:33:40]*
* Model : LE-3500R
* Version : 1.11
* Extension : Standard
* Serial No. : *****
* Start time : 2012-05-18 20:54:18
* Stop time : 2012-05-18 20:54:22
*-----*
* BERT RESULTS
* PROTOCOL: ASYNC
* S-SPEED : 9600 R-SPEED : 9600
* CHAR BIT : 8 STOP BIT : 1
*-----*
    
```

DATE-TIME	LOSS	R-BIT	E-BIT	BIT-ER	E-BLK	BLK-ER	E-SEC	%E.F.S
05/18 20:23	3	323888	639	1.97E-3	58	1.13E-2	9	84.746
05/18 20:24	11	413440	2202	5.33E-3	85	1.30E-2	8	86.207
05/18 20:25	1	402734	215	5.34E-4	12	1.88E-3	3	94.915
05/18 20:26	0	460744	0	0.00E+0	0	0.00E+0	0	100.000
05/18 20:27	7	273059	1401	5.13E-3	50	1.15E-2	0	100.000
05/18 20:28	1	453660	461	1.02E-3	25	3.47E-3	2	96.610
05/18 20:29	0	460752	0	0.00E+0	0	0.00E+0	0	100.000
05/18 20:30	0	460752	0	0.00E+0	0	0.00E+0	0	100.000
05/18 20:31	0	460752	0	0.00E+0	0	0.00E+0	0	100.000
05/18 20:32	0	460752	0	0.00E+0	0	0.00E+0	0	100.000
05/18 20:33	0	460752	0	0.00E+0	0	0.00E+0	0	100.000
05/18 20:34	0	460752	0	0.00E+0	0	0.00E+0	0	100.000
05/18 20:35	0	460744	0	0.00E+0	0	0.00E+0	0	100.000
05/18 20:36	9	406429	1806	4.44E-3	67	1.04E-2	6	89.831
05/18 20:37	0	460752	0	0.00E+0	0	0.00E+0	0	100.000
05/18 20:38	0	460752	0	0.00E+0	0	0.00E+0	0	100.000
05/18 20:39	0	435872	41	9.41E-5	1	1.45E-4	1	98.305
05/18 20:40	3	409525	600	1.47E-3	22	3.38E-3	5	91.228
05/18 20:41	0	460752	0	0.00E+0	0	0.00E+0	0	100.000
05/18 20:42	0	460752	0	0.00E+0	0	0.00E+0	0	100.000
05/18 20:43	6	410997	1200	2.92E-3	43	6.59E-3	7	88.136
05/18 20:44	0	460752	0	0.00E+0	0	0.00E+0	0	100.000
05/18 20:45	0	460752	0	0.00E+0	0	0.00E+0	0	100.000
05/18 20:46	0	460744	0	0.00E+0	0	0.00E+0	0	100.000
05/18 20:47	0	460752	0	0.00E+0	0	0.00E+0	0	100.000
05/18 20:48	0	460752	0	0.00E+0	0	0.00E+0	0	100.000
05/18 20:49	0	460752	0	0.00E+0	0	0.00E+0	0	100.000
05/18 20:50	0	460752	0	0.00E+0	0	0.00E+0	0	100.000
05/18 20:51	2	279704	488	1.74E-3	18	3.60E-3	4	93.220
05/18 20:52	0	415749	0	0.00E+0	0	0.00E+0	0	100.000

## 7.3 Usage on PC

By using PC link software (Light Edition), you can execute real time measurement and convert a captured file into text file. The Captured data is in unique data form thus you need to convert it to use it on PC.

### PC link software “LE-PC300R (Light Edition)”

With this software you can take the monitor data into PC through USB port, AUX port(serial), Wi-Fi, or storage device.

\* Wi-Fi function is available only in Japan, USA, Canada, and EU nations where the product is needed to be compliant with RE directive (2014/53/EU).

#### ■ Install of PC link software

The Utility folder of attached CD-ROM includes the light edition of the PC link software “LE-PC300R”. Double-click setup.exe in the folder and install it following the install wizard.

#### ■ PC Connection

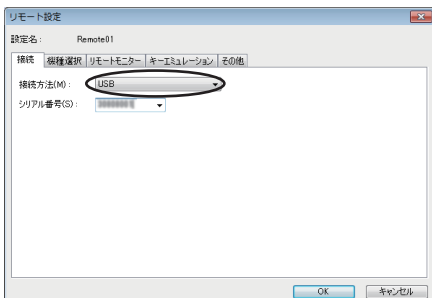





The Utility folder of attached CD-ROM includes the light edition of LE-PC300R.

Double-click setup.exe in the folder and install it following the install wizard.

 When you use USB connection, you need to install the USB driver before the use. The driver is in the Driver folder of attached CD-ROM.

#### ■ Start/Stop measurement

After finishing configuration of communication condition, click  to display and record the measured data. Click  to stop measurement.

-  LE-PC300R (Light Edition) has 10 minutes limitation for measurement time. When you need to measure for more long time please purchase the full edition of LE-PC300R.
-  For “how to use” of LE-PC300R (Light Edition), refer to the online help of LE-PC300R.

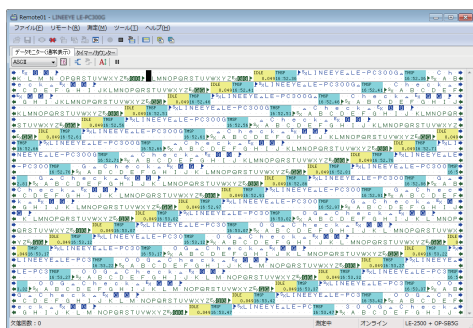

#### ■ Text conversion

You can convert the data file which is measured by the analyzer into text file. By clicking  of LE-PC300R, the text conversion window opens. Then select the folder which has the data to be converted and select the data. You can select normal format or translation format for the text conversion. You can also convert it to csv format.



 LE-PC300R (Light Edition) has 3 files limitation (at one time) for the file conversion. When you need to convert many files at one time, please purchase the full edition of LE-PC300R.

#### ■ Save

Click  to save the data which was measured by LE-PC300R.



# Chapter 8 Save and Load Data

It is possible to save the measured data and setting conditions in a SD card or USB flash.

## 8.1 Storage Device

- USB flash and SD card (LINEEYE option) are available.

Options: SD-8GX, SD-16GX, SD-32GX

Do not eject the storage device while saving, auto saving, and auto backup.

## 8.2 File Management Function

You can format (initializing), load (readout), save (storing) and delete (erase) of memory card.

### Directory Display

```
◀ DIRECTORY ▶ [USB] REMAIN 68MB
♦ TGSAVE33.DT 1480 16-10-28 14:03:08
TGSAVE34.DT 1480 16-10-28 14:03:08
#000005.DT 61M 16-10-31 18:45:34
#000006.DT 69M 16-11-01 9:38:06
SELECT FUNCTION PUSH PAGE UP DOWN
0:SAVE 1:LOAD 2:DELETE
```

To display the directory screen, press [LOAD/SAVE] in the top menu ([Menu]). When you insert both USB flash and SD card, directory display can be changed by [LOAD]/[SAVE].

- Do not display while measuring.
- Scroll by [▲], [▼], [PAGE UP], [PAGE DOWN].

If a storage device is not set, the “INSERT MEDIA” message is displayed. Insert a USB flash or SD card.

- The files are as follows.

Extension	Contents
DT	Measured data
SU	Condition for communication measurement (including data tables and simulation programs)

- A file saved by the auto save function is automatically named.#nnnnnnn.DT (n means sequence number from 0.)
- A file saved by the trigger save is automatically named. TGSAVEnn.DT (n means sequence number from 0.)

6.1 Trigger Function  
6.5 Logging Function for a Long Time

### Format (Initializing)

- Format message will appear if the storage device needs to be formatted. Or press [SHIFT]+[F] in the directory screen to format the storage device.

```
◀ DIRECTORY ▶ [USB] REMAIN 68MB
FORMAT ?
[ENTER] : YES [STOP] : NO
PUSH PAGE UP DOWN
```

Press [ENTER] to format the CF card.  
Press [STOP] to cancel.

- Once you format the storage device, the saved files will be erased and cannot be recovered.
- When you need to format the SD card, format it on your PC by using SDFormaterv4 offered by SD Association.



To display the file save screen, press [0] in the directory screen.

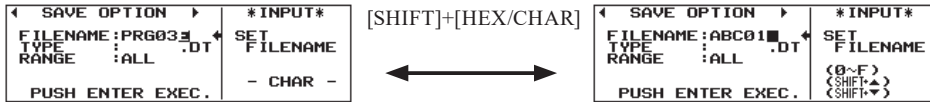

1. Enter the file name. Digits 0-9, letters A-F can be entered with the keys. Press [SHIFT]+[HEX/CHAR] to change to Character/HEX input mode.

2.4 Input Character and Binary Data

2. To select a file, move the “ ← ” mark to “TYPE :”. Specify the range to save the measurement data (. DT).  
 ALL : All monitor data in the buffer memory.  
 CURRENT- : The specified number of data starting with the page currently on display. (1k each)
3. Press [ENTER] to start saving, after completion of the saving operation, the screen returns to the directory display. If the amounts of data to be saved exceed the remaining capacity of the storage device, the error message is displayed in the last line and the saving operation is interrupted. When this happens, try again after reducing the range of data to be saved or deleting unnecessary files.

 Attention	Do not turn off the power of the analyzer or remove the storage device while saving the data.
---------------	---

Filter



- ◆ To display the filter screen, press [SHIFT]+[FIND]. Then, you can display specific files you wish to check.
- |          |              |  |
|----------|--------------|--|
| TYPE     | 0 : ALL      | All the files  |
|          | 1 : LINEEYE  | All the files saved on analyzers                         |
|          | 2 : SETUP    | Setup files  |
|          | 3 : DATA     | Data files (xxxxxxx.DT)                                  |
|          | 4 : TGSAVE   | Trigger save files (TGSAVEEnn.DT)                        |
|          | 5 : AUTOSAVE | Autosave files (#nnnnnnn.DT)                             |
| MIN TMSP | 0 : OFF      | All the files  |
|          | 1 : ON       | Files with the updated date of after the specified date  |
| MAX TMSP | 0 : OFF      | All the files  |
|          | 1 : ON       | Files with the updated date of before the specified date |
- ◆ Pressing [FIND] makes you switch the filter function to valid or invalid. When the file filter is valid, [FILTER ON] appears on the right bottom of the screen.

Load

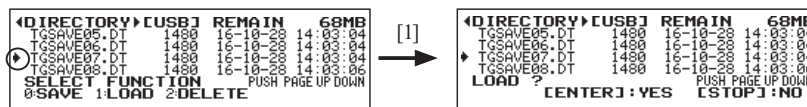

1. Move the “ ► ” mark to the left side of the file to be loaded with [▲], [▼].
2. Press [1] to display the file loading screen.
3. Press [ENTER] for loading. When [STOP] is pressed, loading can be cancelled.
  - Once loading is executed, communication conditions or data in capture memory are overwritten.
  - LINEEYE analyzers are compatible in measurement data file. Part of files or data saved in higher hierarchy models or new modes, however, may not be available in lower hierarchy models or conventional models.

Specified file deletion



1. Move the “▶” mark with [▲], [▼], to the left side of the file to be deleted.
2. To display the file deleting screen, press [2].
3. Press [ENTER] for deletion. To cancel the deletion, press [STOP].

All files deletion

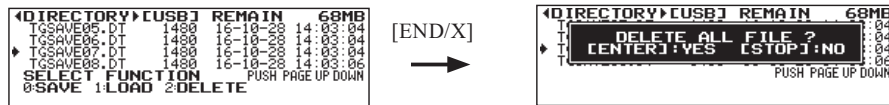

1. To display the file deleting screen, press [2] in the directory screen. Press [END/X].
2. To delete all the files simultaneously, press [ENTER]. To cancel the deletion, press [STOP].

File Filter Deletion

1. To display the files you wish to delete, set the file filter function valid.
2. Selecting all files deletion makes you delete only files which match the filter conditions.
  - It is useful to delete the only trigger save files, the files of before the specified date, etc.

To change the file name, load the file and save it with the different name.

There are 14 kinds of error as follows when you use the memory card. If you happen to have an error, check them and must take the suitable steps.

Error Message	Meaning
NO MEDIA	No storage device has been inserted.
ILLEGAL CARD	An unacceptable card for the analyzer has been inserted.
ILLEGAL MBR	Master boot record (MBR) is illegal. MBR was never formatted or is damaged.
UNKNOWN FORMAT	Format style is unknown. It is not formatted or formatted illegally.
ILLEGAL MEDIA	Some illegal media exists in the management area.
DIRECTORY FULL	Capacity of the directory is full.
NOT ENOUGH REMAIN	Not enough remain of capacity in the data area.
ACCESS DENIED	Some illegal access was attempted, such as deletion of read-only files.
FILE EXIST	The same file or sub-directory name is already existed.
DATA ERROR	The file to be loaded contains illegal data. The file is unsupported or damaged.
WRITE PROTECTED	The file cannot be loaded, because selected buffer is write-protected. 2.5 Environmental Setting (Conditions)
BUFFER FULL	Loading of a data file exceeding the capacity of selected buffer has been attempted.
I/O ERROR	Error in hardware occurred during input/output process.
ILLEGAL FILENAME	Useless filename in this analyzer was specified.

## 9.1 Calculation of Block Check

Block check is calculated as follows:

### ■ ASYNC, SYNC BSC Transmission

Start of calculation :When any one of the characters set to “BGN CHAR” is received, calculation will start with the next character.

End of calculation :When any one of the characters set to “END CHAR” is received, calculation will finish just after the character.

BCC check:When the calculation end character is received after the calculation start character has been received, data next to the calculation end character will be checked as the BCC.

The ITB code is applied equally to the calculation end character.

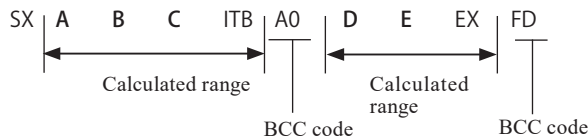
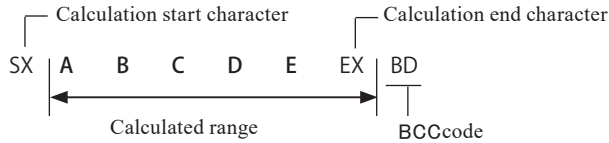

### ■ HDLC SDLC Transmission

- Start of calculation:After flag-synchronization has been established, calculation starts with the first data received.

- End of calculation :The characters before the synchronization reset flag are calculated.

- FCS check : The character just before the synchronization reset flag is checked as FCS.

### ■ Transparent mode (only for ASYNC, SYNC BSC)

- If you select “ON” for the “TRANSPRT” setting, the Analyzer will enter the transparent mode and calculate BCC as follows.

- The character set in the “DLE” setting is handled as the Data Link Escape code.

- The calculation starts and ends block upon <DLE+calculation start code> and <DLE+calculation end code>, respectively. The calculation end code without DLE is treated as normal character.

- The DLE code is excluded from the calculation of BCC.

If two DLE codes appear successively, only the first DLE code will be excluded. The second DLE code will be treated as a normal character and therefore be included in the calculation of BCC.

- Synchronization code “SYNC CHR” without DLE code is considered as normal characters, and Synchronization code with DLE code is excepted from the calculation.

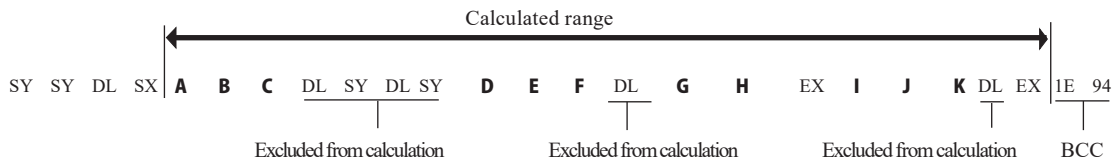

•The block of the calculation starting with the calculation start code without DLE is the same as that when “TRANSPRT” is set to “OFF.”

### ■ Modbus

- Calculation range will be from address field to data field.

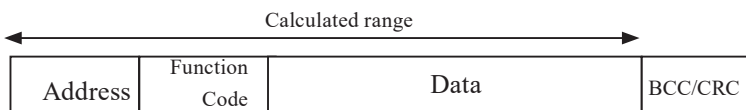

■ Reference

• LRC code

LRC O : Longitudinal parity odd

LRC E : Longitudinal parity even

(‘LRC E’ is normally used.)

• CRC code generating polynomial

CRC-6 :  $X^6 + X^5 + 1$

CRC-12 :  $X^{12} + X^{11} + X^3 + X^2 + X + 1$

CRC-16 :  $X^{16} + X^{15} + X^2 + 1$

CRC-ITU-T :  $X^{16} + X^{12} + X^5 + 1$

• FCS code generating polynomial

FCS-16 :  $X^{16} + X^{12} + X^5 + 1$

FCS-32 :  $X^{32} + X^{26} + X^{23} + X^{22} + X^{16} + X^{12} + X^{11} + X^{10} + X^8 + X^7 + X^5 + X^4 + X^2 + X + 1$

(All one initial)

## 9.2 Communication Clock

For the synchronous communications (SYNC / BSC, HDLC / SDLC), when transmitting/receiving data in synchronization with an external clock, there are three patterns of transmission/reception clocks of DTE/DCE as follows. When monitoring and testing synchronous communication by the analyzer, set the “CLOCK” item in the configuration appropriately according to the specifications of the communication device.

📖 Generally, it becomes the follows with the transmission clock of DTE.

■ When the DTE transmits data in synchronization with its own ST1 clock

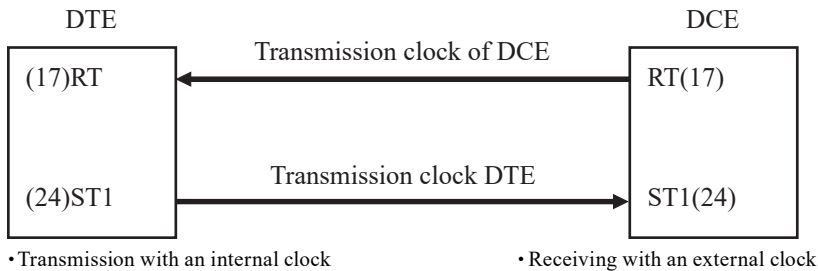

■ When the DTE transmits data in synchronization with the ST2 clock of DCE

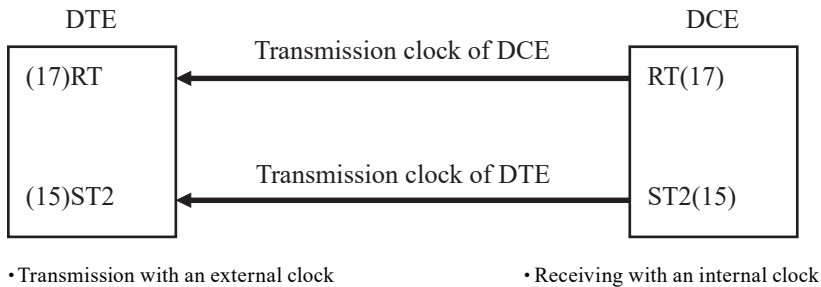

■ When the DTE transmits data in synchronization with the RT clock of DCE

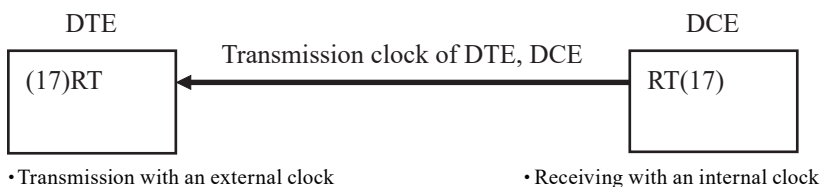

◇ AR (Auto Regulation)

AR refers to a data receiving process using the internal clock by detecting a change in the received data and implementing topology synchronization in accordance to the change. This process requires the channel speed to be the same as that of the transmitting/receiving equipment.

The analyzer allows selection of the synchronous clock with “CLOCK” to enable monitoring and simulating with any clock setting. The analyzer also allows to change specifications of the port with “DTE/DCE mode” in order to simulate the device whichever of DTE and DCE by an attached cable.

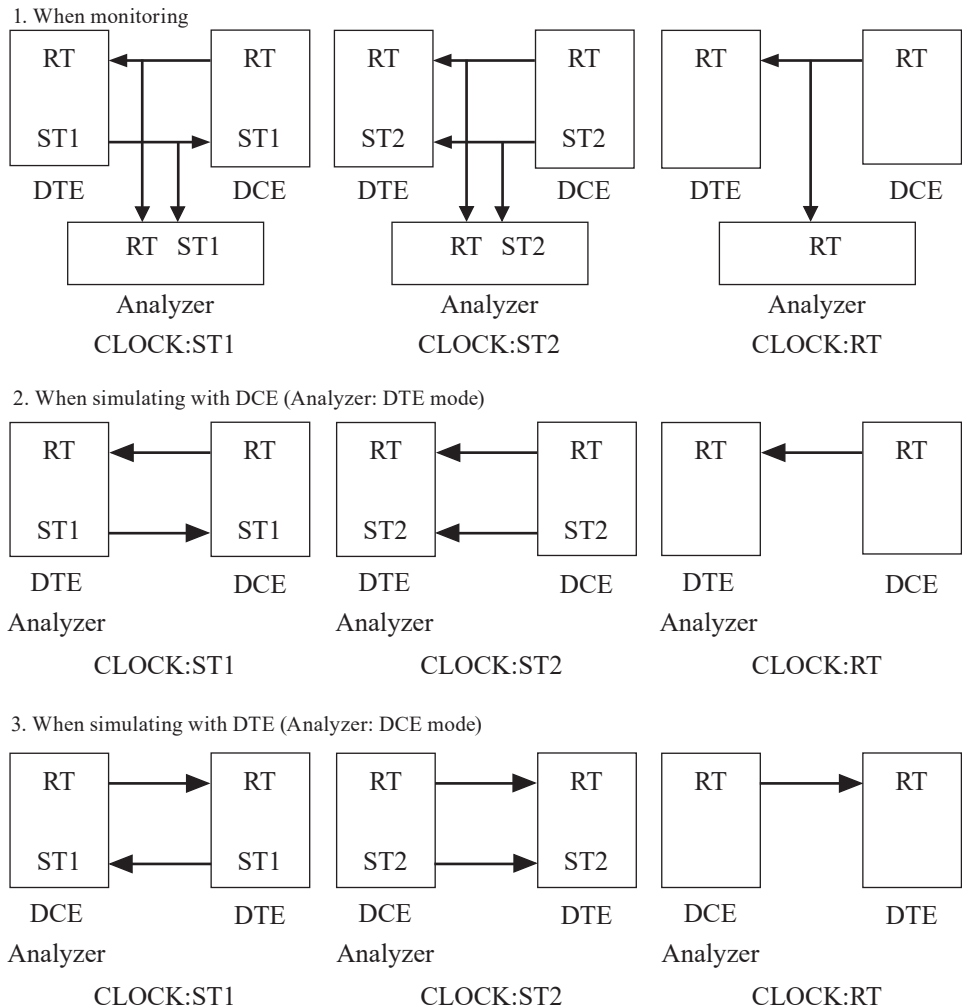

## 9.3 Frame

Definition of 1 frame for each protocol is as follows :

Protocol	Definition of 1 frame
ASYNC	A data string of either idle time (between 1 and 100ms) which is set at "FRM TIME" or character which is set at "FRM END".
SYNC BSC	A data string from a synchronized character (SYNC CHR) until a synchronization release character (RST CHR).
HDLC • SDLC	A data string from a flag to a flag.
PPP	A data string from a flag character to a flag character. Escape code is not decoded.
MODBUS	ASCII: A data string from the start code(0x3A) to end code(0x0D 0x0A) RTU: Detection of the non communication time of silent interval (3.5 characters or more)
I2C	A data string from the detection of start sequence to the detection of stop sequence
SPI	Active time of SS signal

## 9.4 Data Code Table

- Blank boxes (non-defined code) appeared in the code tables are displayed in hexadecimal code.
- JIS7 EBCD and Baudot codes, SHIFT IN display and SHIFT OUT display are alternated in accordance to the SI SO data.
- Display is started with the SHIFT IN display, immediately after operating RUN.
- When SI is received first, the SHIFT IN is displayed until the next SO is received.
- When SO is received first, the SHIFT OUT is displayed until the next SI is received.

### ■ ASCII

	0	1	2	3	4	5	6	7
0	NU	DL	△	0	@	P	`	p
1	SH	D1	!	1	A	Q	a	q
2	SX	D2	”	2	B	R	b	r
3	EX	D3	#	3	C	S	c	s
4	ET	D4	\$	4	D	T	d	t
5	EQ	NK	%	5	E	U	e	u
6	AK	SY	&	6	F	V	f	v
7	BL	EB	’	7	G	W	g	w
8	BS	CN	(	8	H	X	h	x
9	HT	EM	)	9	I	Y	i	y
A	LF	SB	*	:	J	Z	j	z
B	VT	EC	+	;	K	[	k	{
C	FF	FS	,	<	L	\	l	
D	CR	GS	-	=	M	]	m	}
E	SO	RS	.	>	N	^	n	~
F	SI	US	/	?	O	_	o	DT

### ■ EBCDIC

	0	1	2	3	4	5	6	7	8	9	A	B	C	D	E	F
0	NU	DL	DS		△	&	-						{	}	\	0
1	SH	D1	SS				/		a	j	~		A	J		1
2	SX	D2	FS	SY					b	k	s		B	K	S	2
3	EX	D3	WS	IR					c	l	t		C	L	T	3
4	PF	RE	BP	PN					d	m	u		D	M	U	4
5	HT	NL	LF	TN					e	n	v		E	N	V	5
6	LC	BS	EB	NS					f	o	w		F	O	W	6
7	DT	PC	EC	ET					g	p	x		G	P	X	7
8	GE	CN	SA	S2					h	q	y		H	Q	Y	8
9	SI	EM	SE	IT					i	r	z		I	R	Z	9
A	RT	US	SM	RF	¢	!		:								
B	VT	C1	CP	C3	.	\$	,	#								
C	FF	IF	MA	D4	<	*	%	@								
D	CR	IG	EQ	NK	(	)	_	’								
E	SO	RS	AK		+	;	>	=								
F	SI	IB	BL	SB		~	?	^								

■ JIS7(7)

For Roman characters

SHIFT IN

	0	1	2	3	4	5	6	7
0	NU	DL	△	0	@	P	`	p
1	SH	D1	!	1	A	Q	a	q
2	SX	D2	”	2	B	R	b	r
3	EX	D3	#	3	C	S	c	s
4	ET	D4	\$	4	D	T	d	t
5	EQ	NK	%	5	E	U	e	u
6	AK	SY	&	6	F	V	f	v
7	BL	EB	’	7	G	W	g	w
8	BS	CN	(	8	H	X	h	x
9	HT	EM	)	9	I	Y	i	y
A	LF	SB	*	:	J	Z	j	z
B	VT	EC	+	;	K	[	k	{
C	FF	FS	,	<	L	¥	l	
D	CR	GS	-	=	M	]	m	}
E	SO	RS	.	>	N	^	n	~
F	SI	US	/	?	O	_	o	DT

- When SI is received first, Roman characters are displayed until the next SO is received.

For Kana characters

SHIFT OUT

	0	1	2	3	4	5
0	NU	DL	△	-	タ	ミ
1	SH	D1	。	ア	チ	ム
2	SX	D2	「	イ	ツ	メ
3	EX	D3	」	ウ	テ	モ
4	ET	D4	、	エ	ト	ヤ
5	EQ	NK	・	オ	ナ	ユ
6	AK	SY	ヲ	カ	ニ	ヨ
7	BL	EB	ア	キ	ヌ	ラ
8	BS	CN	イ	ク	ネ	リ
9	HT	EM	ウ	ケ	ノ	ル
A	LF	SB	エ	コ	ハ	レ
B	VT	EC	オ	サ	ヒ	ロ
C	FF	FS	ャ	シ	フ	ワ
D	CR	GS	ユ	ス	ヘ	ン
E	SO	RS	ヨ	セ	ホ	°
F	SI	US	ッ	ソ	マ	°

- When SO is received first, Kana (Japanese characters) are displayed until the next SI is received.

■ JIS(8)

	0	1	2	3	4	5	6	7	8	9	A	B	C	D	E	F
0	NU	DL	△	0	@	P	`	p				-	タ	ミ		
1	SH	D1	!	1	A	Q	a	q			。	ア	チ	ム		
2	SX	D2	”	2	B	R	b	r			「	イ	ツ	メ		
3	EX	D3	#	3	C	S	c	s			」	ウ	テ	モ		
4	ET	D4	\$	4	D	T	d	t			、	エ	ト	ヤ		
5	EQ	NK	%	5	E	U	e	u			・	オ	ナ	ユ		
6	AK	SY	&	6	F	V	f	v			ヲ	カ	ニ	ヨ		
7	BL	EB	’	7	G	W	g	w			ア	キ	ヌ	ラ		
8	BS	CN	(	8	H	X	h	x			イ	ク	ネ	リ		
9	HT	EM	)	9	I	Y	i	y			ウ	ケ	ノ	ル		
A	LF	SB	*	:	J	Z	j	z			エ	コ	ハ	レ		
B	VT	EC	+	;	K	[	k	{			オ	サ	ヒ	ロ		
C	FF	FS	,	<	L	¥	l				ャ	シ	フ	ワ		
D	CR	GS	-	=	M	]	m	}			ユ	ス	ヘ	ン		
E	SO	RS	.	>	N	^	n	~			ヨ	セ	ホ	°		
F	SI	US	/	?	O	_	o	DT			ッ	ソ	マ	°		

■ EBCDIK

	0	1	2	3	4	5	6	7	8	9	A	B	C	D	E	F
0	NU	DL	DS		△	&	-			ソ			{	}	\	0
1	SH	D1	SS				/		ア	タ	~		A	J		1
2	SX	D2	FS	SY					イ	チ	へ		B	K	S	2
3	EX	D3	WS	IR					ウ	ツ	ホ		C	L	T	3
4	PF	RE	BP	PN					エ	テ	マ		D	M	U	4
5	HT	NL	LF	TN					オ	ト	ミ		E	N	V	5
6	LC	BS	EB	NS					カ	ナ	ム		F	O	W	6
7	DT	PC	EC	ET					キ	ニ	メ		G	P	X	7
8	GE	CN	SA	S2					ク	ヌ	モ		H	Q	Y	8
9	SI	EM	SE	IT					ケ	ネ	ヤ		I	R	Z	9
A	RT	US	SM	RF	¢	!		:	コ	ノ	ユ	レ				
B	VT	C1	CP	C3	.	¥	,	#				ロ				
C	FF	IF	MA	D4	<	*	%	@	サ		ヨ	ワ				
D	CR	IG	EQ	NK	(	)	_	'	シ	ハ	ラ	ン				
E	SO	RS	AK		+	;	>	=	ス	ヒ	リ	ゝ				
F	SI	IB	BL	SB		-	?	”	セ	フ	ル	°				

■ Baudot

SHIFT IN

	0	1
0	NU	T
1	E	Z
2	LF	L
3	A	W
4	△	H
5	S	Y
6	I	P
7	U	Q
8	CR	O
9	D	B
A	R	G
B	J	SO
C	N	M
D	F	X
E	C	V
F	K	SI

SHIFT OUT

	0	1
0	NU	5
1	3	”
2	LF	)
3	-	2
4	△	#
5	'	6
6	8	0
7	7	1
8	CR	9
9	\$	?
A	4	&
B	BL	SO
C	,	.
D	!	/
E	:	;
F	(	SI



■ EBCD  
SHIFT IN

	0	1	2	3
0	Δ	2	1	3
1	-	k	j	l
2	@	s	/	t
3	&	b	a	c
4	8	0	9	#
5	q	VT	r	\$
6	y	FF	z	,
7	h		i	.
8	4	6	5	7
9	m	o	n	p
A	u	w	v	x
B	d	f	e	g
C		SO	RS	ET
D		BS	CR	SY
E		EB	LF	EC
F		SI	HT	DT

SHIFT OUT

	0	1	2	3
0	Δ	<	=	;
1	_	K	J	L
2		S	?	T
3	+	B	A	C
4	*	)	(	”
5	Q	VT	R	!
6	Y	FF	Z	,
7	H		I	.
8	:	,	%	>
9	M	O	N	P
A	U	W	V	X
B	D	F	E	G
C		SO	RS	ET
D		BS	CR	SY
E		EB	LF	EC
F		SI	HT	DT

■ Transcode

	0	1	2	3
0	SH	&	_	0
1	A	J	/	1
2	B	K	S	2
3	C	L	T	3
4	D	M	U	4
5	E	N	V	5
6	F	O	W	6
7	G	P	X	7
8	H	Q	Y	8
9	I	R	Z	9
A	SX	Δ	EC	SY
B	.	\$	,	#
C	<	*	%	@
D	BL	US	EQ	NK
E	SB	ET	EX	EM
F	EB	DL	HT	DT

■ IPARS

	0	1	2	3
0			@	\$
1	1	/	J	A
2	2	S	K	B
3	3	T	L	C
4	4	U	M	D
5	5	V	N	E
6	6	W	O	F
7	7	X	P	G
8	8	Y	Q	H
9	9	Z	R	I
A	0	-	:	?
B	*	#	<	.
C	CR	Δ	+	%
D	EI	EC	EU	EP
E	=	[	)	S2
F		,	(	SI

## 9.5 Specifications of Translation Display

### BSC Translation Display

Only the control characters used in the BSC communication are displayed.

Transmission control character	Display	EBCDIC (EBCDIK)	ASCII (JIS)	Transcode
SOH	SH	01	01	00
STX	SX	02	02	0A
ETB	EB	26	17	0F
ETX	EX	03	03	2E
EOT	ET	37	04	1E
ENQ	EQ	2D	05	2D
ACK0	<sup>A</sup> K0	10 70	10 30	1F 20
ACK1	<sup>A</sup> K1	10 61	10 31	1F 23
NAK	<sup>N</sup> K	3D	15	3D
DLE	<sup>D</sup> L	10	10	1F
ITB	<sup>I</sup> B(Us)	1F	1F	1D
WACK	WAK	10 6B	10 3B	1F 26
RVI	RV	10 7C	10 3C	1F 32
TTD	TD	02 2D	02 05	0A 2D
ACK	<sup>A</sup> K	2E	06	-

- ☞ A character next to DLE is always displayed unconditionally.
- ☞ The character string between STX and ETB or ETX is omitted and displayed as "-". While the control codes between them are also not displayed, only ITB is displayed together with the result of the BCC calculation.
- ☞ The results of the BCC calculation are displayed when the text is completed.

### Frame Level Translation Display

#### ■ SDLC, HDLC frame constitution

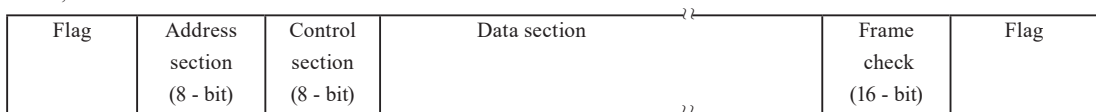

#### ■ Translation screen

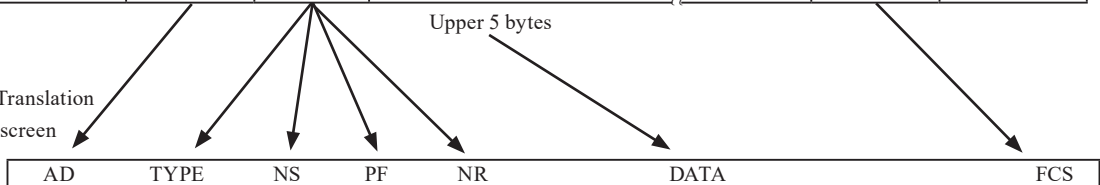

■ List of SDLC mnemonics (Modulo 8)

Mnemonic		Name		Bit configuration of control							
SD	RD	SD	RD	b8	b7	b6	b5	b4	b3	b2	b1
INFO	INFO	INFOmation		N(R)			P/F	N(S)			0
RR	RR	Receive Ready		N(R)			P/F	0	0	0	1
RNR	RNR	Recieve Not Ready		N(R)			P/F	0	1	0	1
REJ	REJ	REJect		N(R)			P/F	1	0	0	1
SNRM		Set Normal Responce Mode		1	0	0	P	0	0	1	1
SNRME		Set Normal Response ModeExtended		1	1	0	P	1	1	1	1
DISC	RD	DISConnect	Request Disconnect	0	1	0	P/F	0	0	1	1
SIM	RIM	Set Initialization Mode	Request InitializationMode	0	0	0	P/F	0	1	1	1
	DM	Disconnect Mode		0	0	0	F	1	1	1	1
UP		Unnumbered Poll		0	0	1	P	0	0	1	1
	UA	Unnumbered Acknowledgement		0	1	1	F	0	0	1	1
UI	UI	Unnumbered IDentification		0	0	0	P/F	0	0	1	1
XID	XID	eXchange IDentification		1	0	1	P/F	1	1	1	1
	FRMR	FReMe Reject		1	0	0	F	0	1	1	1
TEST	TEST	TEST		1	1	1	P/F	0	0	1	1
	BCN	BeaCoN		1	1	1	F	1	1	1	1
CFGR	CFGR	ConFiguRe		1	1	0	P/F	0	1	1	1

☞ When a control section of a bit-configuration without the above is received, it is displayed in hexadecimal code.

■ List of SDLC mnemonics (Modulo 128)

Mnemonic	Name	Bit configuration of control									
		b16~10	b9	b8	b7	b6	b5	b4	b3	b2	b1
INFO	INFOmation	N(R)	P/F	N(S)						0	
RR	Receive Ready	N(R)	P/F	0	0	0	0	0	0	0	1
RNR	Recieve Not Ready	N(R)	P/F	0	0	0	0	0	1	0	1
REJ	REJect	N(R)	P/F	0	0	0	0	1	0	0	1

☞ When a control section of a bit-configuration without the above is received, it is displayed in the same code to Modulo 8.

■ List of X.25 mnemonics (Modulo 8)

Mnemonic		Name		Bit configuration of control							
SD	RD	SD	RD	b8	b7	b6	b5	b4	b3	b2	b1
INFO	INFO	INFOmation		N(R)			P/F	N(S)			0
RR	RR	Receive Ready		N(R)			P/F	0	0	0	1
RNR	RNR	Recieve Not Ready		N(R)			P/F	0	1	0	1
REJ	REJ	REJect		N(R)			P/F	1	0	0	1
SARM	DM	Set Asynchronous Responce Mode	DisconnectMode	0	0	0	P/F	1	1	1	1
SABM		Set AsynchronousBalanced Mode		0	0	1	P	1	1	1	1
SABME		Set AsynchronousBalanced ModeExtended		0	1	1	P	1	1	1	1
DISC		DISConnect		0	1	0	P	0	0	1	1
	UA	Unnumbered Acknowledgement		0	1	1	F	0	0	1	1
	FRMR	FRaMe Reject		1	0	0	F	0	1	1	1

☞ When a control section of a bit-configuration without the above is received, it is displayed in hexadecimal code.

■ List of X.25 mnemonics (Modulo 128)

Mnemonic		Name		Bit configuration of control							
SD	RD	SD	RD	b8	b7	b6	b5	b4	b3	b2	b1
INFO	INFO	INFOmation		N(S)							0
				N(R)							PF
RR	RR	Receive Ready		0	0	0	0	0	0	0	1
				N(R)							P
RNR	RNR	Recieve Not Ready		0	0	0	0	0	1	0	1
				N(R)							PF
REJ	REJ	REJect		0	0	0	0	1	0	0	1
				N(R)							PF

☞ When a control section of a bit-configuration without the above is received, it is displayed in the same code to Modulo 8.

■ LAPD frame configuration

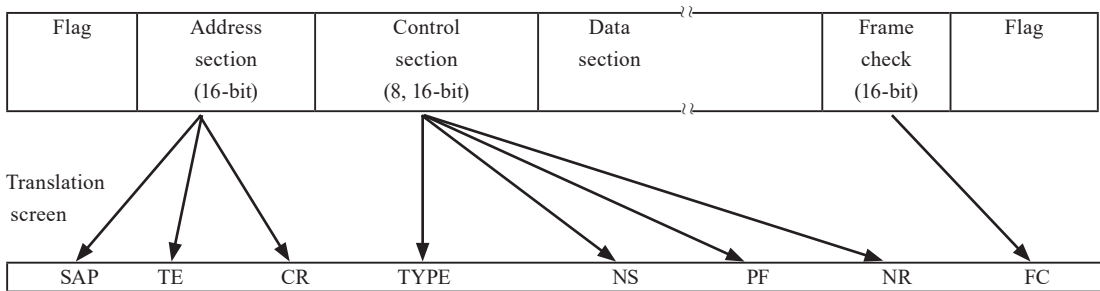

■ List of LAPD mnemonics

Mnemonic		Name		Bit configuration of control							
SD	RD	SD	RD	b8	b7	b6	b5	b4	b3	b2	b1
INFO		INFOmation		N(S)							0
				N(R)							P
RR	RR	Receive Ready		0	0	0	0	0	0	0	1
				N(R)							P/F
RNR	RNR	Recieve Not Ready		0	0	0	0	0	1	0	1
				N(R)							P/F
REJ	REJ	REJect		0	0	0	0	1	0	0	1
				N(R)							P/F
SABME		Set Asynchronous BalancedMode Extended		0	1	1	P	1	1	1	1
				DM	Disconnected Mode		0	0	0	F	1
UI		Unnumbered Infomation		0	0	0	P	0	0	1	1
DISC		DISConnect		0	1	0	P	0	0	1	1
	UA	Unnumbered Acknowledgement		0	1	1	F	0	0	1	1
	FRMR	FRaMe Reject		1	0	0	F	0	1	1	1
XID	XID	eXchange IDentification		1	0	1	P/F	1	1	1	1

☞ When a control section of a bit-configuration without the above is received, it is displayed in hexadecimal code.

■ X.25 packet configuration

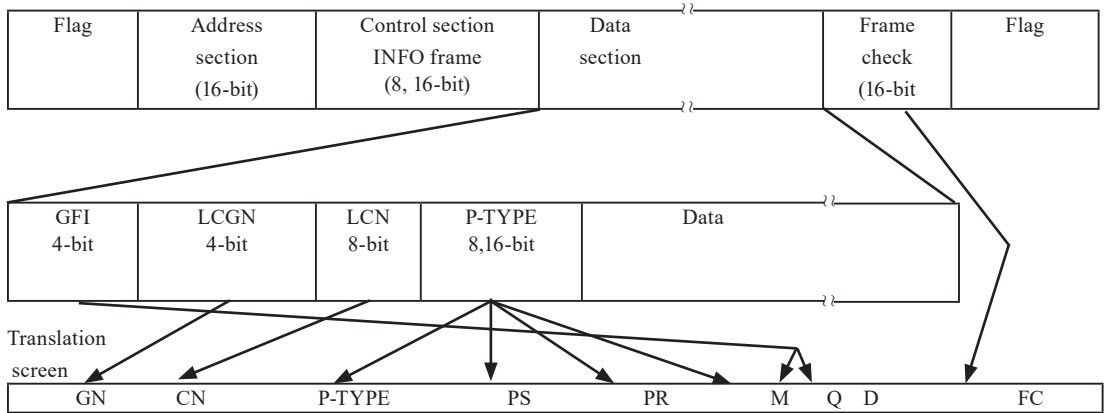

■ Translation screen



■ List of X.25 mnemonics

Mnemonic		Name		Bit configuration of packet type							
SD	RD	SD	RD	b8	b7	b6	b5	b4	b3	b2	b1
DT	DT	Data		P(R)		M	P(S)			0	
RR	RR	Receiver Ready		P(R)		0	0	0	0	1	
RNR	RNR	Receve Not Ready		P(R)		0	0	1	0	1	
REJ		REJect		P(R)		0	1	0	0	1	
CR	IC	Call Request	Incoming Call	0	0	0	0	1	0	1	1
CA	CC	Call Accept	Call Connected	0	0	0	0	1	1	1	1
CQ	CI	Clear reQuest	Clear Indication	0	0	0	1	0	0	1	1
CF	CF	Clear conFirmation		0	0	0	1	0	1	1	1
SQ	SI	reStart reQuest	reStart Indication	1	1	1	1	1	0	1	1
SF	SF	reStart conFirmation		1	1	1	1	1	1	1	1
RQ	RI	Reset reQuest	Reset Indication	0	0	0	1	1	0	1	1
RF	RF	Reset conFirmation		0	0	0	1	1	1	1	1
REGQ		REGister(Facility)reQuest		1	1	1	1	0	0	1	1
	REGF	REGister(Facility) conFirmation		1	1	1	1	0	1	1	1
IT	IT	InTerrupt		0	0	1	0	0	0	1	1
IF	IF	Interrupt conFirmation		0	0	1	0	0	1	1	1
DIAG	DIAG	DIAGnostic		1	1	1	1	0	0	0	1

■ LAPD packet configuration

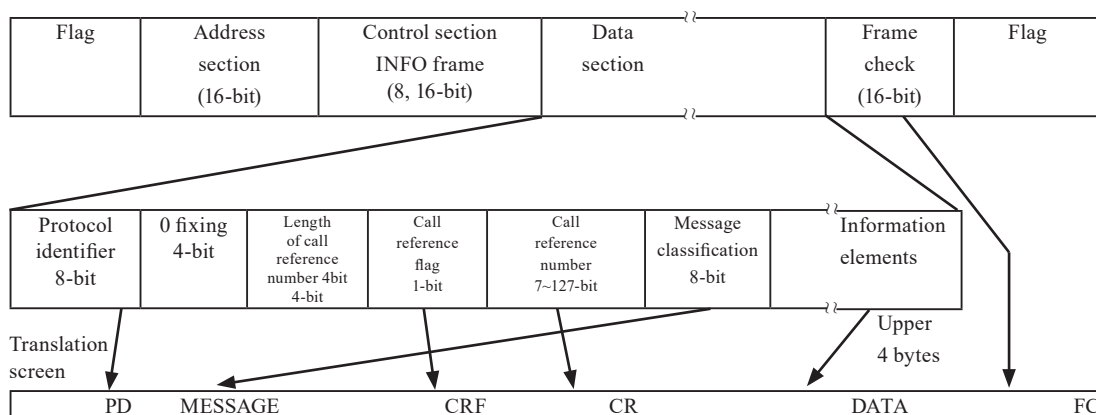

■ Translation screen

■ List of LAPD mnemonics

Mnemonic	Name	Bit configuration of message							
		b8	b7	b6	b5	b4	b3	b2	b1
ESCAPE	ESCAPE	0	0	0	0	0	0	0	0
ALERT	ALERTing	0	0	0	0	0	0	0	1
CALL PROC	CALL PROCeeding	0	0	0	0	0	0	1	0
CONN	CONNect	0	0	0	0	0	1	1	1
CON NACK	CONNect ACKnowledge	0	0	0	0	1	1	1	1
PROG	PROGress	0	0	0	0	0	0	1	1
SETUP	SETUP	0	0	0	0	0	1	0	1
SETUP ACK	SETUP ACKnowledge	0	0	0	0	1	1	0	1
RES	RESume	0	0	1	0	0	1	1	0
RES ACK	RESume ACKnowledge	0	0	1	0	1	1	1	0
RES REJ	RESume REJect	0	0	1	0	0	0	1	0
SUSP	SUSPend	0	0	1	0	0	1	0	1
SUSP ACK	SUSPend ACKnowledge	0	0	1	0	1	1	0	1
SUSP REJ	SUSPend REJect	0	0	1	0	0	0	0	1
USER INFO	USER INFOrmation	0	0	1	0	0	0	0	0
DISC	DISConnect	0	1	0	0	0	1	0	1
REL	RELease	0	1	0	0	1	1	0	1
REL COMP	RELease COMPlete	0	1	0	1	1	0	1	0
REST	REStart	0	1	0	0	0	1	1	0
REST ACK	REStart ACKnowledge	0	1	0	0	1	1	1	0
SEGMENT	SEGMENT	0	1	1	0	0	0	0	0
CON CON	CONgestion CONTrOl	0	1	1	1	1	0	0	1
INFO	INFOrmation	0	1	1	1	1	0	1	1
FAC	FACility	0	1	1	0	0	0	1	0
NOTIFY	NOTIFY	0	1	1	0	1	1	1	0
STATUS	STATUS	0	1	1	1	1	1	0	1
STATUS EN	STATUS ENqiry	0	1	1	1	0	1	0	1

■ PPP frame constitution

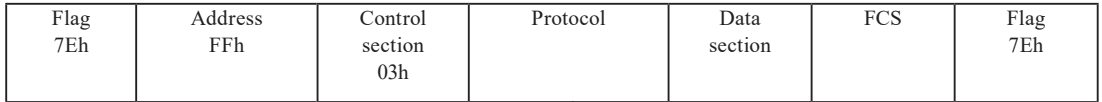

■ Translation screen



Protocol value (h)	Mnemonic	Name
0001	Padding	Padding Protocol
0021	IP	Internet Protocol
0023	OSI	OSI Network Layer
0025	XNS	Xerox NS IDP
0027	DECnet	DECnet Phase IV
0029	AT	AppleTalk
002b	IPX	Novell IPX
002d	VJCTCPIP	Van jacobson Compressed TCP/IP
002f	VJUTCPIP	Van jacobson Uncompressed TCP/IP
0031	BPDU	Bridging PDU
0033	ST	Stream Protocol (TS-II)
0035	VINES	Banyan Vines
0039	AT-EDDP	AppleTalk EDDP
003b	AT-SB	AppleTalk SmartBuffered
003d	MP	Multi-Link
003f	NETBIOS	NETBIOS Framing
0041	Cisco	Cisco Systems
0043	Ascom	Ascom Timeplex
0045	LBLB	Fujitsu Link Backup and Load Barancing
0047	DCA	DCA Remote Lan
0049	SDTP	Serial Data Transport Protocol (PPP-SDTP)
004b	SNA802.2	SNA over 802.2
004d	SNA	SNA
004f	IPv6	IPv6 Header Compression
006f	SB	Stampede Bridging
00fb	CSLMG	Compression on single link in multilink group
00fd	1stComp	1st choice compression
0201	802.1dHP	802.1d Hello Packet
0203	SR-BPDU	IBM Source Routing BPDU
0205	DECLBST	Dec LANBridge 100 Spanning Tree
0231	Luxcom	Luxcom

Protocol value (h)	Mnemonic	Name
233	SigmaNS	Sigma Network Systems
8021	IPCP	Internet Protocol Control Protocol
8023	OSINLCP	OSI Network Layer Control Protocol
8025	XNSCP	Xerox NS IDP Control Protocol
8027	DNCP	DECnet Phase IV Control Protocol
8029	ATCP	Apple Talk Control Protocol
802b	IPXCP	Novell IPX Control Protocol
8031	BCP	Bridging NCP
8035	BVCP	Banyan Vines Control Protocol
803d	MPCP	Multi-Link Control Protocol
803f	NETBIOSC	NETBIOS Framing Control Protocol
8041	CiscoCP	Cisco Systems Control Protocol
8043	AscomCP	Ascom Timeplex
8045	LBLBCP	Fujitsu LBLB Control Protocol
8047	DCA-CP	DCA Remote Lan Network Control Protocol
8049	SDCP	Serial Data Control Protocol (PPP-SDCP)
804b	SNA802CP	SNA over 802.2 Control Protocol
804d	SNACP	SNA Control Protocol
804f	IPv6CP	IPv6 Header Compression Protocol
806f	SBCP	Stampede Bridging Control Protocol
80fb	CSLMGCP	compression on single link in multilink group control
80fd	CCP	Compression Control Protocol
c021	LCP	Link Control Protocol
c023	PAP	Password Authentication Protocol
c025	LQR	Link Quality Report
c027	SPAP	Shiva Password Authentication Protocol
c029	CBCP	CallBack Control Protocol (CBCP)
c223	CHAP	Challenge Handshake Authentication Protocol
c26f	SBAP	Stampede Bridging Authorization Protocol
c281	PropAP	Proprietary Authentication Protocol
c481	PropNIDA	Proprietary Node ID Authentication Protocol



# Chapter 10 Specifications and Maintenance

## 10.1 Specifications of Function and Hardware

Model		LE-3500R	LE-2500R
Interface	RS-232C (V. 24)	◎	
	RS-422/485	◎	
	TTL/I2C/SPI	◎	
Expansion Interface (*1)	X. 20/21	○ [ OP-SB10N ] + [ LE-25Y15 ]	
	RS-449	○ [ OP-SB10N ] + [ LE-25Y15 ]	
	V. 35	○ [ OP-SB10N ] + [ LE-25M34 ]	
	TTL	○ [ OP-SB5GL ]	
	Current Loop	○ [ OP-SB1C ]	
	CAN/LIN	○ [ OP-SB7GX ]	
Expansion Firmware(*1)	High Speed HDLC/SPI	○ [ OP-FW10R ]	Not Supported
Standard Protocol	Asynchronous, Asynchronous PPP	◎	
	Character synchronous SYNC/ BSC	◎	
	Bit synchronous HDLC/SDLC/X. 25	◎	
	MODBUS	◎	Not Supported
Expansion Protocol	I <sup>2</sup> C	○	
	SPI	○	
	BURST (*2)	○	
	IrDA(IrLAP) (*3)	○	
	CC-Link (*4)	○	△ 1Mbps or less only
	CAN	○	
	Device Net (*4)	○	
	LIN	○	
Capture Memory	Memory capacity (*5)	64MB	
	Backup Memory	Save about 5 years by the built-in lithium battery	
Transmission speed	Max speed in full-duplex	2.048Mbps	1.000Mbps
	Max speed in half-duplex	2.048Mbps	1.000Mbps
	Speed setting range	50bps ~ 2.048Mbps	50bps ~ 1.000Mbps
	Setting step	Freely set to four effective digits, separately for transmission and reception. (Margin of error: +/- 0.01% or less)	
Online monitor function		Communication log is recorded continuously and displayed in the CD without affecting the communication lines. Displays idle time, time stamps and line state etc.	
Line Status LED		SD, RD, RS, CS, ER, DR, CD, CI, ST1, ST2, RT	

Model		LE-3500R	LE-2500R
Signal Voltage Measurement		Measure volage of SD, RD, ER(DTR) and CD(DCD) on RS-232C, TXD, RXD, RTS, CTS on TTL Range: +/- 15V, Resolution: 0.1V	
Statistical analysis function		⊙	—
Logic analyzer function		1KHz to 20MHz (14 steps) Min. 2,000 samplings	
Bit error rate test		Measure error rate conforming to ITU-T Notifiation G.821 parameter.	
Simulation function	Operation Spec	Enables transmission/ reception test of any given data in DTE or DCE mode (selectable with pin arrangements).	
MANUAL	Manual mode	⊙	
FLOW	Flow control mode	⊙	
ECHO	Echo mode	⊙	
POLLING	Polling mode	⊙	
BUFFER	Buffer resend mode	⊙	—
PROGRAM	Program mode	⊙	—
SD card interface	Max. card capacity (*6)	32GB	16GB
Wi-Fi interface (*7)	IEEE802.11b/g/n	Frequency range : 2400MHz-2483.5MHz TX POWER: +20dBm(802.11b), +17dBm(802.11g), +14dBm(802.11n)	
LCD display		Monochrome 240×64 dot with Back-light	
AUX(RS-232C) port		Mini DIN 8pin connnector Communication Speed : 9600bps ~ 230.4Kbps (6 steps)	
USB2.0 device port		Support High speed transmission in Device B connector for PC connection.	
USB2.0 host port		Support High speed transmission in Host A connector for USB flash drive.	
AC adapter		Attached AC adapter, Input : AC100 ~ 240V, 50/60Hz	
Built-in secondary battery		Nickel metal hydride (Model : P-19S) Battery charging time : About 2.5H Battery operation time : About 6.5 - 8H(*8)	
Temprature, Humidity		In operation : 0 ~ 40°C In storage : -10 ~ 50°C under 85%RH	
Regulatory Approvals		CE ( class A )	
Dimensions (W×D×H)		210(W)×154(D)×38(H) mm	
Weight		Approx. 760g	

\*1 : Supported with option product in [ ].

\*2 : Mode in which all data is imported in synch with clock edge.

\*3 : The expansion kit for Infrared Communications Expansion Kit(IrDA) has been discontinued.

\*4 : Raw data display only. High-speed CC-Link requires extended firmware OP-FW10R.

\*5 : Transmission/ reception data, idle time, time stamp, and line state consume 4 bytes of memory at each capture.

\*6 : Operation is not guaranteed with SD cards not specified by LINEEYE when using.

\*7: Wi-Fi function is available only in Japan, USA, Canada, and EU nations where the product is needed to be compliant with RE directive (2014/53/EU). The Wi-Fi function of this product is set to invalid depending on the country where it is shipped. Please contact LINEEYE for the detail.

\*8 : When LCD back-light is OFF (6.5H when using TTL port., .8H when using RS-232C port)

## 10.2 Ports

### RS-422/485 port

This port is used for measuring and testing RS-422/485. Input/output specifications of each signal can be changed by setting monitor (MONITOR), simulation DTE (SIM-DTE), and simulation DCE (SIM-DCE).

#### ■ Signal definition of RS-422/485 port

 2.2 Set the Measurement Port (INTERFACE SETUP)

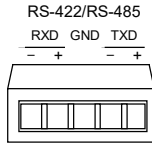

Signal	Terminal	Input/Output(*1)			Linestate LED
		Monitor	SIM-DTE	SIM-DCE	
Transmission data	TXD-	I	O	I	SD[A]:-
	TXD+	I	O	I	SD[B]:+
Receiving data	RXD-	I	I	O	RD[A]:-
	RXD+	I	I	O	RD[B]:+
Signal Ground	GND	-	-	-	RS[A]:-

\*1: "I" is an input to the analyzer. "O" is an output from the analyzer.

### TTL Port

TTL (UART), SPI, and I2C port for measurement and test

#### ■ TTL (UART) signal definition

 2.2 Set the Measurement Port

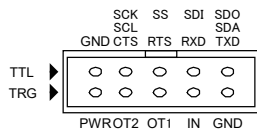

Connector: 2.54mm pitch  
Pin header type

Signal	Pin name	Input/Output(*1)		Linestate LED
		MONITOR	SIMULATION	
Transmission data	TXD-	I	O	SD
Receiving data	RXD-	I	I	RD
RTS	RTS	I	O	RS
CTS	CTS	I	I	CS
Signal Ground	GND	-	-	

#### ■ I2C

Signal	Pin name	Input/Output(*1)			Linestate LED
		MONITOR	SIMULATION		
			Master	Slave	
SDA	SDA	I	I/O	I/O	SD
SCL	SCL	I	O	I	ST1
Signal Ground	GND	-	-		

#### ■ SPI

Signal	Pin name	Input/Output(*1)			Linestate LED
		MONITOR	SIMULATION		
			Master	Slave	
MOSI	SDO	I	O	O(*2)	SD
MISO	SDI	I	I	I(*2)	RD
SS	SS	I	O	I	RS
SCK	SCK	I	O	I	ST1
Signal Ground	GND	-	-		

\*1: "I" is an input to the analyzer. "O" is an output from the analyzer.

\*2: For SLAVE simulation, connect the SDO of this unit to the MISO to be tested and the SDI of this unit to the MOSI to be tested.

## RS-232C (V.24) port

This port is used for measuring and testing RS-232C. The standard pin arrangement is used on the specification of V.24. Input/Output specifications of each signal can be changed by setting monitor(MONITOR), simulation DTE (SIM-DTE), and simulation DCE (SIM-DCE).

### ■ Signal definition of RS-232C

 2.2 Set the Measurement Port

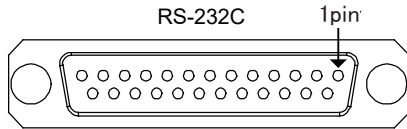

Signal name	RS-232C(V.24)		Signal Input / Output(*3)			LineState LED	LineState LED (JIS standard)
	DSUB25	Pin(*2)	MONITOR	DTE	DCE		
Shield ground	FG	1	-	-	-		
Signal ground	SG	7	-	-	-		
Transmission data	SD	2	I	O	I	SD	SD
Receiving data	RD	3	I	I	O	RD	RD
Request of transmission	RTS	4	I	O	I	RTS	RS
Capable of transmission	CTS	5	I	I	O	CTS	CS
Terminal ready	DTR	20	I	O	I	DTR	ER
Data set ready	DSR	6	I	I	O	DSR	DR
Data carrier detect	DCD	8	I	I	O	DCD	CD
Call indicator	CI (*1)	22	I	I	-	RI	CI
Transmission timing DTE	ST1	24	I	O	I	TXC1	ST1
Transmission timing DCE	ST2	15	I	I	O	TXC2	ST2
Receive timing DCE	RT	17	I	I	O	RXC	RT

\*1:CI signal cannot be outputted from this analyzer.

\*2:The pins not mentioned are for non-connection.

\*3:“I” is an input to the analyzer. “O” is an output from the analyzer.

## External Input/Output Terminal

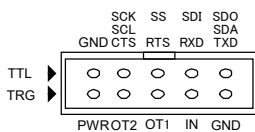

Connector: 2.54mm pitch  
pin header type

Signal name	Pin name	Input/Output
Power for external circuit(*1)	PWR	
External trigger output 2 (TTL level output)(*2)	OT2	O
External trigger output 1 (TTL level output)(*2)	OT1	O
External trigger input (TTL level input)(*3)	IN	I
Signal GND	GND	-

\*1: “I” is an input to the analyzer. “O” is an output from the analyzer

 2.2 Set the Measurement Port

\*2: For SLAVE simulation, connect the SDO of this unit to the MISO to be tested and the SDI of this unit to the MOSI to be tested.

\*3: When the measurement port is set to TTL and the simulation is executed, the set TTL voltage is output (max. 30mA)

## AUX(RS-232C) Port

The dedicated port to communicate with external devices equipped with RS-232C interface.

Pin number	Signal name	I/O	Description
1	Empty terminal		
2	SG	-	Signal ground
3	AUX CS	I	Set to "Low" level to inhibit data output from the analyzer.
4	AUX RD	I	Receives data from an external device.
5	AUX RS	O	Remains on 'High' level when the analyzer is ready for data input.
6	AUX ER1	O	Remains on 'High' level while the power of the analyzer is ON.
7	AUX SD	O	Outputs data to external device.
8	AUX ER2	O	Remains on 'High' level while the power of the analyzer is ON.

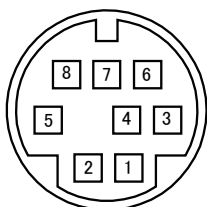

Connector: Mini DIN 8pin connector (female)  
TCS7588-01-201 or the like

### <AUX cable (LE2-8V)>

The analyzer (AUX port)		External device (RS-232C)	
Mini DIN connector		DSUB connector	
Pin number		Pin number	Name
1	—————	4	DTR
2	—————	5	GND
3	—————	7	RTS
4	—————	3	SD
5	—————	8	CTS
6	—————	1	DCD
7	—————	2	RD
8	—————	6	DSR
Metal shell	—————	Metal shell	

## USB Device port

USB device port is used to communicate a PC via USB2.0 port.

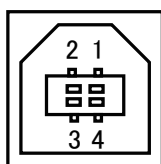

Connector specification: Type B (Female)

Pin No.	Signal	Description
1	VCC	+5 VDC
2	D-	data -
3	D+	data +
4	GND	signal ground

## USB Host port

USB host port is used to connect USB flash.

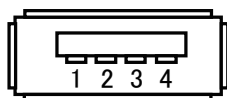

Connector specification: Type A (Female)

Pin No.	Signal	Description
1	VCC	+5 VDC
2	D-	data -
3	D+	data +
4	GND	signal ground

## USB Driver Installation

---

USB port is used to update the latest firmware via PC or use an optional PC software.

You need to install a driver in the PC.

 Supported OS are Windows XP/Vista/7/8/8.1/10.

### <Installation>

#### ●Windows Vista/7/8

1.Set the attached CD-ROM into the CD-ROM drive of the PC.

2.Execute "setup.exe" file in "Driver" folder of the attached CD-ROM.

3."User Account Control" appers in the display of the PC.

Then click "Yes".

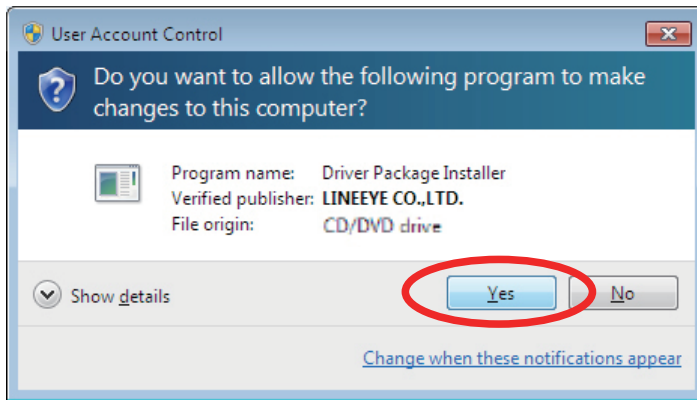

4."LINEEYE driver package installer" appears. Then click "Yes".

5."Device Driver Installation Wizard" appears. Then click "Next".

6.Windows security window appears.

Then click "Install".

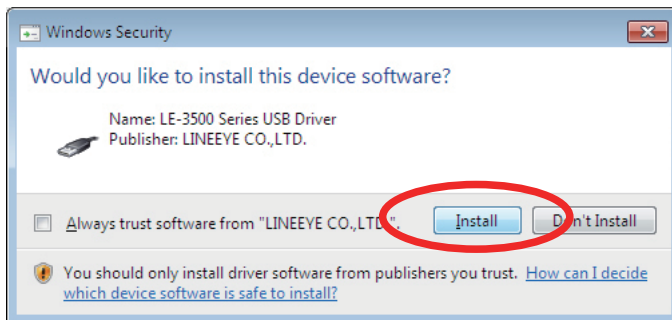

7.If the window says "Completing the Device Driver Installation Wizard", click "Finish".

8.Connect the analyzer to the PC. The installation is completed if the message like below is appears on the task tray.

 Above is the installation for Windows 7. It will be almost same for Windows Vista/8.

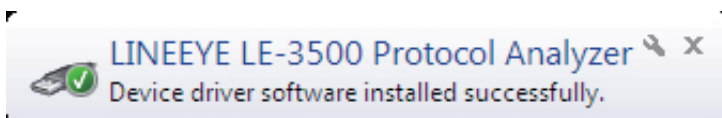

## 10.3 Soft Reset

---

Soft reset means restoring the analyzer to the initial conditions at the time of delivery. (factory setting)

Turn on the power switch, while pressing [ENTER]+[TOP/DEL] keys. [INITIALIZED!] will be displayed in the opening screen.

```
Copyright ©2016 LINEEYE CO., LTD.  
MULTI PROTOCOL ANALYZER  
LE-3500R  
INITIALIZED! Version 1.00  
SB12
```

- ☰ Soft reset clears all data, including the monitor data in the buffer.

## 10.4 Using the Latest Function

---

The new function addition and the improved latest firmware are published on our web page.

After you download to your PC, it is easy to rewrite up to date via attached AUX cable.

- ☰ To learn more about detailed method to rewrite, please refer to LE8FIRM.TXT recorded in the Utility folder of attached CD.

## 10.5 Troubleshooting

■ This section describes how to solve problems when the analyzer does not operate normally.

Problem	Cause / Remedy
Cannot turn on the power	<ul style="list-style-type: none"> <li>• Charge the battery.</li> <li>• The battery reached its life span.</li> <li>• The product is breakdown if BT LED is not blinking green while connecting the AC adaptor.</li> </ul>
Battery cannot be recharged	<ul style="list-style-type: none"> <li>• If BT LED is not lighting, supply the power (AC adaptor).</li> <li>• If BT LED is blinking fast, the product is breakdown or disconnection.</li> <li>• Recharge under the temperature of 5-40°C .</li> <li>• The battery reached its life span.</li> </ul>
Cannot display any	<ul style="list-style-type: none"> <li>• Adjust the contrast.</li> <li>• Use the product under the temperature of 0-40°C .</li> </ul>
Cannot use the backlight	<ul style="list-style-type: none"> <li>• Press [MENU]-&gt;[3]-&gt;[6] and select “BL OFF” to other than “0”. ”0” is for the automatic backlight off for saving power.</li> </ul>
Display <Firmware loader>	<ul style="list-style-type: none"> <li>• Insert the sub-board.</li> <li>• Load the necessary firmware in the analyzer.</li> </ul>
Disappear measured data	<ul style="list-style-type: none"> <li>• If you press [RUN], previous measured data will be erased.</li> <li>• Built-in battery reached its life span. Please ask LINEEYE to replace it.</li> </ul>
Date or time is not displayed correctly.	<ul style="list-style-type: none"> <li>• Display DATE/TIME on the condition menu and set the correct date and time.</li> <li>• Built-in battery reached its life span if date becomes incorrect often.</li> </ul>
Cannot operate any keys	<ul style="list-style-type: none"> <li>• Cannot operate any keys while accessing to the CF card.</li> <li>• Cannot operate any keys while using the PC link software (LE-PC300G).</li> <li>• Remove all cables. Key operation become extremely slow when high speed data is measured.</li> </ul>
Cannot work well A part of display is not correct	<ul style="list-style-type: none"> <li>• Turn off the power and then turn on the power again.</li> <li>• Reset the software (turn on the power while pressing [ENTER]+[TOP/DEL]). It will go back to the factory setting and erase all data.</li> </ul>
Line state LED does not light	<ul style="list-style-type: none"> <li>• Connect the cable properly</li> <li>• Make sure a port you connect cable is same in the setting ([Menu]-&gt;[1]-&gt;[PORT]).</li> <li>• Check the cable snapping or disconnection.</li> </ul>
Line State LED lights but cannot monitor or display anything	<ul style="list-style-type: none"> <li>• Select “On Line” monitor function.</li> <li>• Press [MENU]-&gt;[0] and set appropriate conditions. Check speed, SYNC clock and SYNC characters etc.</li> </ul>
Line State LED lights but cannot monitor and display errors	<ul style="list-style-type: none"> <li>• Select “On Line” monitor function.</li> <li>• Press [MENU]-&gt;[0] and set appropriate conditions. Check speed, data length, parity bit, FCS and BCC etc.</li> </ul>
Errors occur in the target device when pressing [RUN]	<ul style="list-style-type: none"> <li>• Select “On Line” monitor function. Output signals collide if selecting Simulation.</li> </ul>
Cannot output data in Simulation or BERT	<ul style="list-style-type: none"> <li>• Select “Simulation” or “BERT” function.</li> <li>• Press [MENU]-&gt;[1] and select appropriate interface.</li> <li>• Press [MENU]-&gt;[0] and set appropriate conditions. Check SYNC clock when measuring SYNC or HDLC.</li> </ul>
Cannot set appropriate conditions by Auto Configuration	<ul style="list-style-type: none"> <li>• Cannot use if the speed of target device is over 115.2Kbps.</li> <li>• Auto Configuration many not be correct because the communication condition of target device varies.</li> </ul>
Cannot use SD card	<ul style="list-style-type: none"> <li>• Use the SD cards which LINEEYE guarantees to use.</li> <li>• Each model of analyzer has max capacity of using the SD card.</li> <li>• Format the SD card by the analyzer.</li> </ul>
Cannot use Wi-Fi	<ul style="list-style-type: none"> <li>• The Wi-Fi function is available only in Japan, USA, Canada, and EU nations where the product is needed to be compliant with RE directive (2014/53/EU).</li> <li>• Confirm your region.</li> <li>• Confirm the setting of SSID and KEY of Wi-Fi.</li> <li>• Move the analyzer to where gives good reception.</li> </ul>
Unable to printout	<ul style="list-style-type: none"> <li>• Select “OUTPUT” to “AUX” from [MENU]-&gt;[3]-&gt;[2].</li> <li>• Select the serial port for DPU-414 printer.</li> </ul>
Cannot connect to a PC via USB port	<ul style="list-style-type: none"> <li>• Install the USB driver in the PC.</li> <li>• Check if the security software interrupt the connection.</li> </ul>



## 10.6 Warranty and After service

---



### Warranty

---

- When you face any problems, please contact LINEEYE distributors or LINEEYE.

- **Warranty**

Within a period of 12 months from the date of shipment, LINEEYE warrants that your purchased products (except consumable parts such as the battery and software) are free of charge from any defects in material and workmanship, only when the products are operated in accordance with procedures described in the documents supplied by LINEEYE. If the defects exist during the Warranty period, please send back the products to LINEEYE distributors or LINEEYE. LINEEYE will repair or exchange them at no charge. In this case, the shipping charge will be at your own expense.

The foregoing warranties are the sole warranties given by LINEEYE. Above warranties shall not be applied to the products that have been modified, repaired or altered (except by LINEEYE) or that have been subjected to unusual physical or electrical stress, misuses, abuse, negligence or accidents.

LINEEYE disclaims all other warranties including the warranties of merchantability fitness for some particular purpose and noninfringement of third party right. LINEEYE cannot promise that the software is error free or will operate without any interruption.



### User Registration

---

For after service and other information, please register in our Website.



### Repair

---

For malfunction, please contact LINEEYE distributors or LINEEYE and tell us following details.

Model	LE-2500R or LE-3500R
Serial Number	8 digit numbers
Purchase Date	Year, Month, Day
Other	Details of malfunction



10.5 Troubleshooting

- **Repair within the warranty**

LINEEYE repairs, following the repair instruction.

Please provide the details of malfunction.

- **Repair after the warranty**

LINEEYE will repair the products at our own expense.

- **Calibration**

Enable to have a hardware calibration test by the analyzer

1. Remove all cables from the analyzer and save the important data.
2. Turn on the power while pressing [1] + [D].
3. Follow the instruction in the screen.
4. “===== O K =====” will be displayed if the result is fine.



### After Support

---

Read "FAQ" in our Website or email us.

Please refer to "FAQ". We also have support by email regarding the technical issue. When you use it, please register your product via our website.

**Website: <https://www.lineeye.com>**

**Email: [info@lineeye.co.jp](mailto:info@lineeye.co.jp)**

===== Memo =====



There is a registration page on our web site.

( <https://www.lineeye.com> )

Please register your product for further support.

We will provide you the firmware update  
information and sales information etc.

## LINEEYE CO., LTD.

4F., Marufuku Bldg., 39-1, Karahashi Nishihiragaki-cho, Minami-ku,  
Kyoto, 601-8468, Japan

Tel : 075(693)0161 Fax : 075(693)0163

URL <https://www.lineeye.com> Email :[info@lineeye.co.jp](mailto:info@lineeye.co.jp)

Printed in Japan

M-A0235RE/LE